

## RECT TUBE

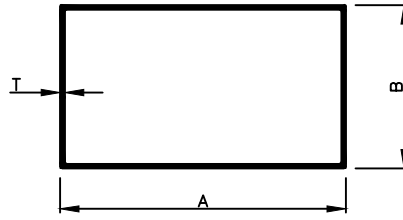

| SEC.No. | C/L | A     | B     | T    | WEIGHT      |
|---------|-----|-------|-------|------|-------------|
| 1068    | 12  | 25.00 | 12.00 | 0.95 | 0.650-0.850 |
| 1000    | 12  | 36.00 | 24.00 | 0.54 | 0.600-0.720 |
| 1001    | 12  | 36.00 | 24.00 | 0.69 | 0.750-0.850 |
| 1002    | 12  | 36.00 | 24.00 | 0.75 | 0.850-1.000 |
| 1003    | 12  | 36.00 | 24.00 | 0.86 | 1.000-1.300 |
| 1004    | 12  | 36.00 | 24.00 | 1.12 | 1.300-1.500 |
| 1025    | 12  | 36.00 | 24.00 | 1.55 | 1.700-2.000 |
| 1042    | 12  | 36.00 | 24.00 | 2.10 | 2.300-2.500 |
| 1069    | 12  | 38.00 | 19.00 | 1.50 | 1.600-1.800 |
| 1070    | 12  | 38.00 | 25.00 | 0.90 | 1.100-1.300 |
| 1029    | 12  | 48.00 | 24.00 | 0.55 | 0.750-0.850 |
| 1005    | 12  | 48.00 | 24.00 | 0.67 | 0.900-1.200 |
| 1006    | 12  | 48.00 | 24.00 | 0.86 | 1.200-1.400 |
| 1007    | 12  | 48.00 | 24.00 | 1.05 | 1.450-1.700 |
| 1009    | 12  | 48.00 | 24.00 | 1.25 | 1.700-1.900 |
| 1010    | 12  | 48.00 | 24.00 | 1.42 | 1.900-2.100 |
| 1011    | 12  | 48.00 | 24.00 | 1.60 | 2.200-2.400 |
| 1012    | 12  | 48.00 | 24.00 | 2.00 | 2.750-3.000 |
| 1071    | 12  | 50.00 | 12.00 | 1.30 | 1.500-1.700 |
| 1072    | 12  | 50.00 | 12.00 | 2.10 | 2.400-2.700 |
| 1073    | 12  | 50.00 | 19.00 | 1.55 | 2.000-2.200 |
| 1044    | 12  | 50.00 | 25.00 | 2.70 | 4.000-4.300 |
| 1022    | 12  | 50.00 | 25.00 | 1.10 | 1.700-1.900 |
| 1030    | 12  | 50.00 | 25.00 | 1.50 | 2.100-2.300 |
| 1036    | 12  | 50.00 | 38.00 | 1.30 | 2.150-2.400 |
| 1038    | 12  | 50.00 | 38.00 | 1.90 | 3.200-3.500 |
| 1067    | 12  | 50.00 | 38.00 | 1.50 | 2.500-2.800 |
| 1039    | 12  | 52.00 | 38.00 | 3.00 | 4.900-5.300 |
| 1024    | 12  | 63.00 | 25.00 | 0.75 | 1.200-1.500 |
| 1114    | 12  | 63.0  | 25.00 | 1.50 | 2.500-2.800 |
| 1013    | 12  | 63.00 | 38.00 | 0.78 | 1.500-1.800 |
| 1014    | 12  | 63.00 | 38.00 | 0.93 | 1.800-2.000 |
| 1015    | 12  | 63.00 | 38.00 | 1.46 | 2.800-3.000 |
| 1023    | 12  | 63.00 | 38.00 | 1.10 | 2.500-2.800 |
| 1037    | 12  | 63.00 | 38.00 | 1.10 | 2.100-2.400 |
| 1041    | 12  | 63.00 | 38.00 | 2.00 | 4.000-4.500 |
| 1066    | 12  | 63.00 | 38.00 | 2.90 | 5.400-5.700 |
| 1074    | 12  | 75.00 | 12.00 | 1.32 | 2.200-2.400 |



SQ. TUBE

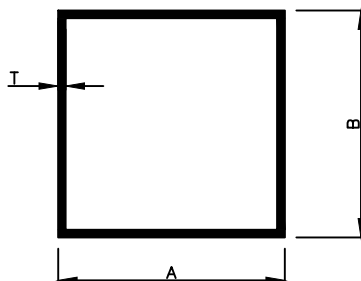

| SEC.No. | C/L | A     | B     | T    | WEIGHT      |
|---------|-----|-------|-------|------|-------------|
| 1062    | 12  | 19.00 | 19.00 |      | 0.600-0.650 |
| 1050    | 12  | 19.00 | 19.00 | 1.20 | 0.800-1.100 |
| 1051    | 12  | 19.00 | 19.00 | 2.00 | 1.300-1.450 |
| 1055    | 12  | 25.00 | 25.00 | 0.78 | 0.750-0.850 |
| 1052    | 12  | 25.00 | 25.00 | 0.95 | 0.900-1.000 |
| 1056    | 12  | 25.00 | 25.00 | 1.65 | 1.500-1.700 |
| 1053    | 12  | 38.00 | 38.00 | 1.09 | 1.600-1.800 |
| 1057    | 12  | 38.00 | 38.00 | 1.50 | 2.100-2.400 |
| 1058    | 12  | 38.00 | 38.00 | 2.00 | 2.800-3.100 |
| 1064    | 12  | 38.00 | 38.00 | 2.80 | 4.000-4.400 |
| 1054    | 12  | 50.00 | 50.00 | 1.06 | 2.000-2.200 |
| 1059    | 12  | 50.00 | 50.00 | 1.40 | 2.600-2.800 |
| 1060    | 12  | 50.00 | 50.00 | 2.00 | 3.800-4.100 |
| 1061    | 12  | 50.00 | 50.00 | 3.00 | 5.600-6.000 |
| 1063    | 12  | 50.00 | 50.00 | 1.60 | 3.000-3.200 |
| 1065    | 12  | 75.00 | 75.00 | 2.00 | 6.000-6.500 |

SINGLE PARTITION

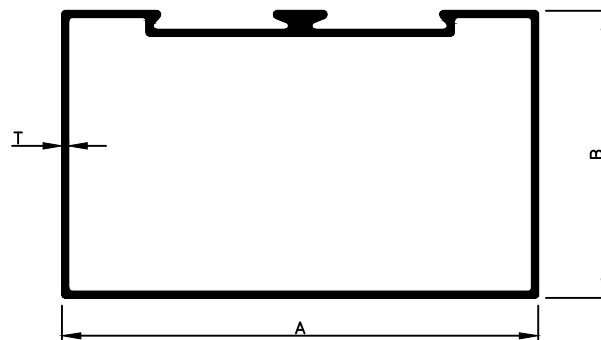

| SEC.No. | C/L | A     | B     | T    | WEIGHT      |
|---------|-----|-------|-------|------|-------------|
| 1081    | 16  | 50.00 | 25.00 | 0.87 | 1.800-2.000 |
| 1090    | 16  | 50.00 | 25.00 | 1.40 | 2.200-2.500 |
| 1082    | 12  | 50.00 | 25.00 | 1.50 | 2.500-2.700 |
| 1083    | 15  | 63.00 | 38.00 | 0.94 | 2.300-2.600 |
| 1095    | 16  | 63.00 | 38.00 | 1.00 | 2.600-2.900 |
| 1091    | 16  | 63.00 | 38.00 | 1.10 | 3.000-3.300 |
| 1084    | 16  | 63.00 | 38.00 | 1.25 | 3.400-3.900 |
| 1096    | 16  | 63.00 | 38.00 | 1.50 | 4.100-4.500 |
| 1085    | 16  | 63.00 | 38.00 | 1.69 | 4.700-5.000 |
| 1086    | 16  | 63.00 | 38.00 | 1.97 | 5.300-5.500 |
| 1093    | 16  | 63.00 | 38.00 | 2.50 | 6.500-6.800 |
| 1092    | 16  | 63.00 | 38.00 | 3.00 | 7.600-8.100 |
| 1087    | 15  | 101.0 | 44.45 | 1.25 | 4.650-4.800 |
| 1094    | 16  | 101.0 | 44.45 | 1.60 | 6.400-6.800 |
| 1088    | 16  | 101.0 | 44.45 | 2.00 | 7.700-7.900 |
| 1089    | 16  | 101.0 | 44.45 | 3.00 | 11.40-11.60 |
| 1097    | 16  | 101.0 | 44.45 | 2.50 | 9.000-10.00 |

DOUBLE PARTITION

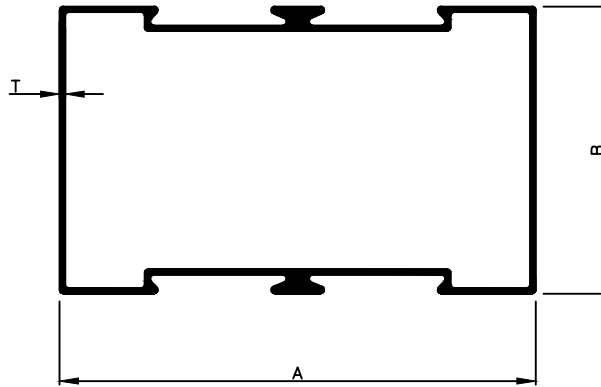

| SEC.No. | C/L | A     | B     | T    | WEIGHT      |
|---------|-----|-------|-------|------|-------------|
| 1121    | 16  | 50.00 | 25.00 | 0.75 | 1.800-2.000 |
| 1122    | 12  | 50.00 | 25.00 | 1.40 | 2.500-2.700 |
| 1123    | 15  | 63.00 | 38.00 | 0.84 | 2.300-2.600 |
| 1135    | 16  | 63.00 | 38.00 | 0.90 | 2.600-2.900 |
| 1131    | 16  | 63.00 | 38.00 | 1.05 | 3.000-3.300 |
| 1124    | 16  | 63.00 | 38.00 | 1.16 | 3.500-3.900 |
| 1125    | 16  | 63.00 | 38.00 | 1.27 | 4.100-4.400 |
| 1126    | 16  | 63.00 | 38.00 | 1.60 | 4.600-5.000 |
| 1127    | 16  | 63.00 | 38.00 | 2.00 | 6.100-6.500 |
| 1133    | 16  | 63.00 | 38.00 | 2.50 | 7.600-8.000 |
| 1132    | 16  | 63.00 | 38.00 | 3.00 | 8.000-8.500 |
| 1128    | 15  | 101.0 | 44.45 | 1.20 | 4.650-4.800 |
| 1134    | 16  | 101.0 | 44.45 | 1.60 | 6.500-6.900 |
| 1129    | 16  | 101.0 | 44.45 | 1.90 | 7.700-7.900 |
| 1130    | 16  | 101.0 | 44.45 | 3.00 | 11.70-11.90 |
| 1137    | 16  | 101.0 | 44.45 | 2.50 | 9.000-10.00 |
|         |     |       |       |      |             |

DOOR MIDDLE SINGLE

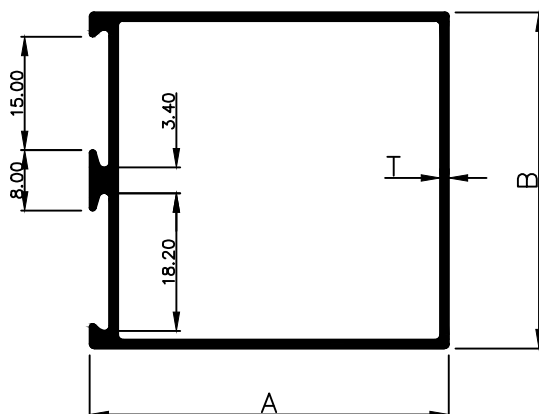

| SEC.No. | C/L | A     | B     | T    | WEIGHT      |
|---------|-----|-------|-------|------|-------------|
| 1161    | 12  | 47.50 | 44.45 | 1.15 | 2.200-2.350 |
| 1162    | 12  | 47.50 | 44.45 | 1.50 | 2.800-2.950 |
| 1163    | 12  | 47.50 | 44.45 | 2.00 | 3.600-3.750 |
| 1164    | 12  | 47.50 | 44.45 | 2.50 | 4.400-4.600 |
| 1165    | 12  | 83.50 | 44.45 | 1.45 | 3.800-4.000 |
| 1166    | 12  | 83.50 | 44.45 | 2.00 | 5.000-5.200 |

DOOR MIDDLE DOUBLE

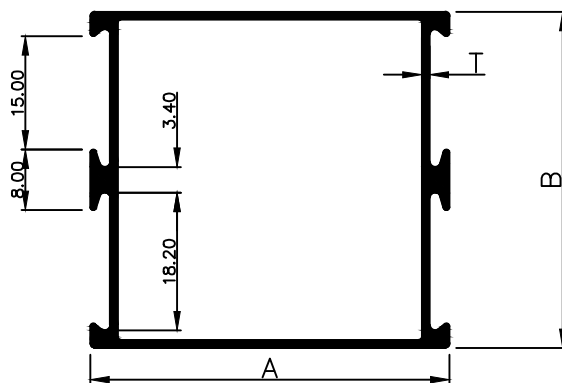

| SEC.No. | C/L | A     | B     | T    | WEIGHT      |
|---------|-----|-------|-------|------|-------------|
| 1180    | 12  | 47.50 | 44.45 | 0.90 | 1.900-2.200 |
| 1181    | 12  | 47.50 | 44.45 | 1.05 | 2.300-2.450 |
| 1187    | 16  | 47.50 | 44.45 | 1.50 | 3.700-4.000 |
| 1182    | 12  | 47.50 | 44.45 | 2.00 | 3.800-3.950 |
| 1183    | 12  | 47.50 | 44.45 | 2.55 | 4.600-4.800 |
| 1184    | 12  | 83.50 | 44.45 | 1.40 | 3.800-4.000 |
| 1185    | 12  | 83.50 | 44.45 | 2.00 | 5.200-5.400 |
| 1188    | 12  | 101.0 | 44.45 | 1.15 | 3.500-3.800 |
| 1190    | 12  | 101.0 | 44.45 | 1.50 | 4.800-5.200 |
| 1186    | 16  | 101.0 | 44.45 | 2.00 | 8.600-9.000 |
| 1189    | 16  | 101.0 | 44.45 | 3.00 | 11.00-13.00 |

DOOR TOP

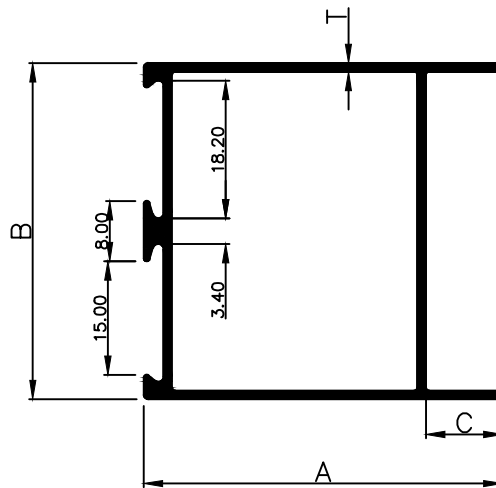

| SEC.No. | C/L | A     | B     | C     | T    | WEIGHT      |
|---------|-----|-------|-------|-------|------|-------------|
| 1201    | 15  | 47.50 | 44.45 | 10.15 | 1.15 | 2.500-2.700 |
| 1203    | 15  | 47.50 | 44.45 | 10.15 | 1.30 | 3.000-3.400 |
| 1202    | 15  | 47.50 | 44.45 | 10.15 | 2.50 | 4.400-4.600 |
| 1204    | 15  | 47.50 | 44.45 | 10.15 | 2.70 | 6.000-6.300 |
|         |     |       |       |       |      |             |

DOOR TOP SINGLE LEG

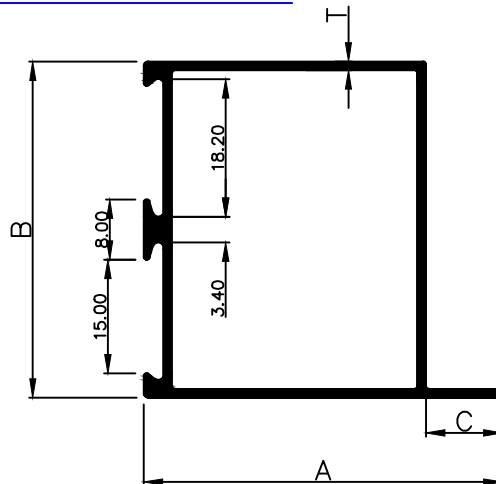

| SEC.No. | C/L | A     | B     | C     | T    | WEIGHT      |
|---------|-----|-------|-------|-------|------|-------------|
| 1221    | 12  | 47.50 | 44.45 | 10.15 | 1.15 | 2.100-2.300 |
| 1222    | 12  | 47.50 | 44.45 | 10.15 | 1.25 | 2.300-2.500 |
| 1223    | 12  | 47.50 | 44.45 | 10.15 | 1.60 | 2.800-3.000 |
|         |     |       |       |       |      |             |

DOOR BOTTOM

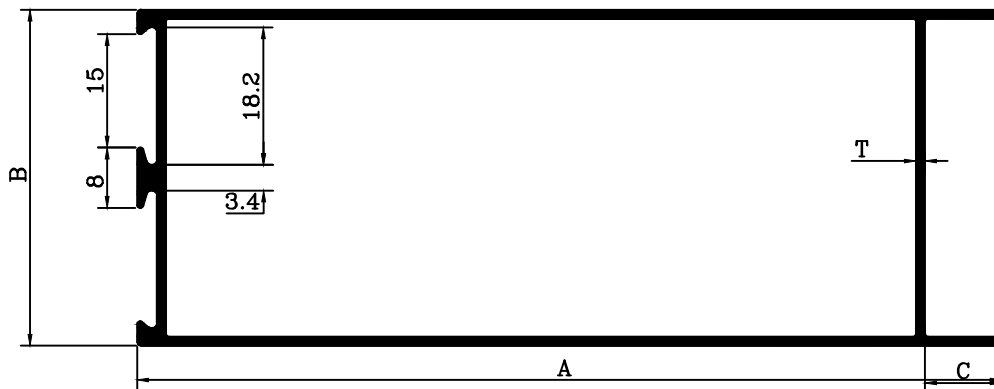

| SEC.No. | C/L | A      | B     | C     | T    | WEIGHT        |
|---------|-----|--------|-------|-------|------|---------------|
| 1240    | 12  | 83.50  | 44.45 | 9.50  | 1.20 | 3.200-3.500   |
| 1241    | 12  | 83.50  | 44.45 | 9.50  | 1.50 | 3.900-4.100   |
| 1242    | 12  | 83.50  | 44.45 | 9.50  | 2.00 | 5.000-5.300   |
| 1243    | 12  | 83.50  | 44.45 | 9.50  | 3.00 | 7.300-7.500   |
| 1249    | 16  | 101.00 | 44.45 | 25.40 | 1.15 | 4.500-5.000   |
| 1251    | 16  | 101.00 | 44.45 | 25.40 | 1.25 | 4.800-5.200   |
| 1250    | 16  | 101.00 | 44.45 | 25.40 | 3.00 | 12.00-14.00   |
| 1244    | 12  | 114.30 | 44.45 | 10.10 | 1.20 | 3.900-4.100   |
| 1245    | 12  | 114.30 | 44.45 | 10.10 | 1.50 | 4.800-5.000   |
| 1246    | 12  | 114.30 | 44.45 | 10.10 | 3.00 | 9.100-9.500   |
| 1247    | 16  | 114.30 | 44.45 | 25.40 | 1.50 | 6.400-6.600   |
| 1248    | 16  | 114.30 | 44.45 | 25.40 | 2.50 | 10.300-10.500 |

DOOR VERTICAL

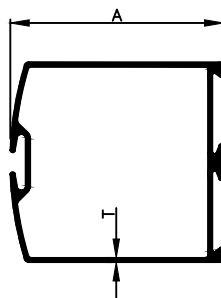

| SEC.No. | C/L | A     | B     | T    | WEIGHT      |
|---------|-----|-------|-------|------|-------------|
| 1261    | 14  | 47.50 | 44.45 | 1.24 | 3.000-3.200 |
| 1266    | 14  | 47.50 | 44.45 | 1.50 | 3.700-4.000 |
| 1264    | 14  | 47.50 | 44.45 | 2.00 | 2.600-2.800 |
| 1262    | 14  | 47.50 | 44.45 | 2.19 | 4.800-5.000 |
| 1267    | 14  | 47.50 | 44.45 | 2.50 | 5.200-5.500 |
| 1269    | 14  | 47.50 | 44.45 | 3.00 | 6.000-6.500 |
| 1265    | 14  | 83.50 | 44.45 | 1.35 | 4.500-4.700 |
| 1263    | 14  | 83.50 | 44.45 | 2.00 | 6.100-6.300 |
| 1268    | 14  | 83.50 | 44.45 | 3.00 | 9.000-9.500 |

GLAZING CLIP

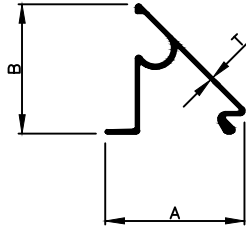

| SEC.No. | C/L | A     | B     | T    | WEIGHT      |
|---------|-----|-------|-------|------|-------------|
| 1280    | 12  | 18.40 | 17.00 | 0.52 | 0.240-0.260 |
| 1281    | 12  | 18.40 | 17.00 | 0.60 | 0.260-0.280 |
| 1282    | 12  | 18.40 | 17.00 | 0.65 | 0.280-0.320 |
| 1283    | 12  | 18.40 | 17.00 | 0.75 | 0.350-0.380 |
|         |     |       |       |      |             |

GLAZING PLATE

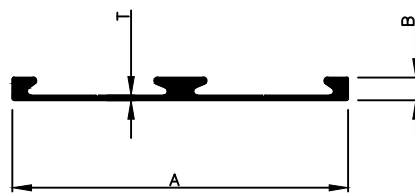

| SEC.No. | C/L | A     | B    | T    | WEIGHT      |
|---------|-----|-------|------|------|-------------|
| 1291    | 12  | 44.00 | 3.40 | 0.69 | 0.500-0.600 |
| 1292    | 12  | 44.00 | 3.40 | 0.78 | 0.600-0.700 |
|         |     |       |      |      |             |
|         |     |       |      |      |             |

GLASS SEC. 12.0 mm SOLID

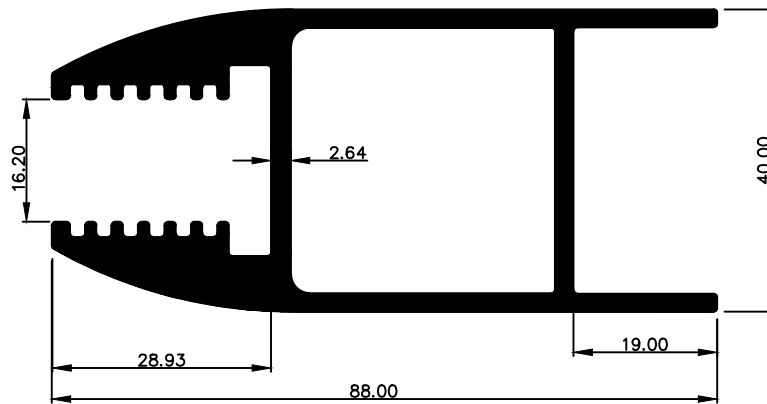

| SEC.No. | C/L | A     | B     | T    | WEIGHT        |
|---------|-----|-------|-------|------|---------------|
| 1302    | 15  | 88.00 | 40.00 | 1.70 | 8.000-8.400   |
| 1301    | 15  | 88.00 | 40.00 | 2.64 | 10.800-11.000 |
|         |     |       |       |      |               |

SAMOSHA SEC.

SEC. NO:-1311

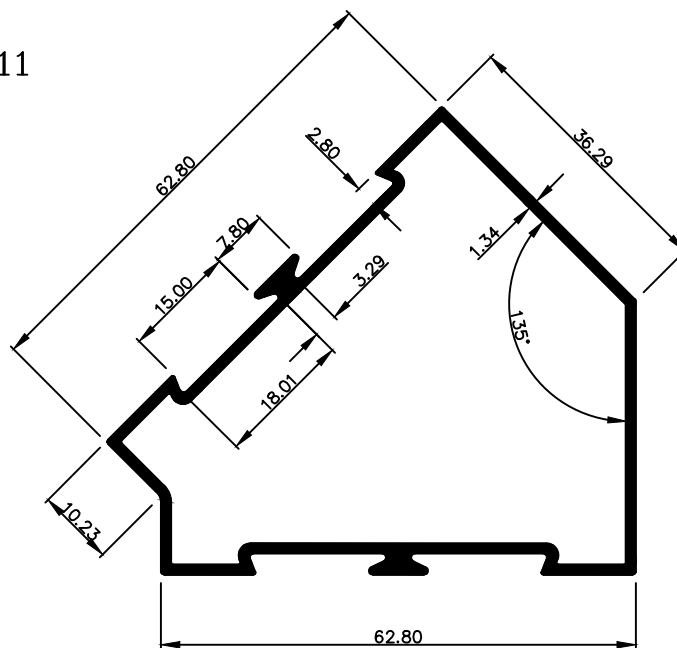

WEIGHT:- 2.800-3.000 kg/12'

CURTAIN WALL

SEC. NO:-1316

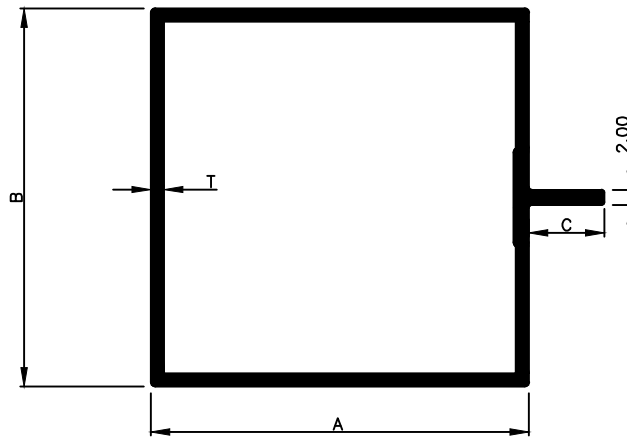

| SEC.No. | C/L | A     | B     | C     | T    | WEIGHT      |
|---------|-----|-------|-------|-------|------|-------------|
| 1317    | 16  | 50.00 | 50.00 | 10.00 | 1.10 | 3.300-3.500 |
| 1316    | 16  | 50.00 | 50.00 | 5.00  | 1.15 | 3.300-3.500 |
| 1318    | 16  | 50.00 | 50.00 | 5.00  | 1.30 | 3.800-4.100 |

CURTAIN WALL

SEC. NO:-1321

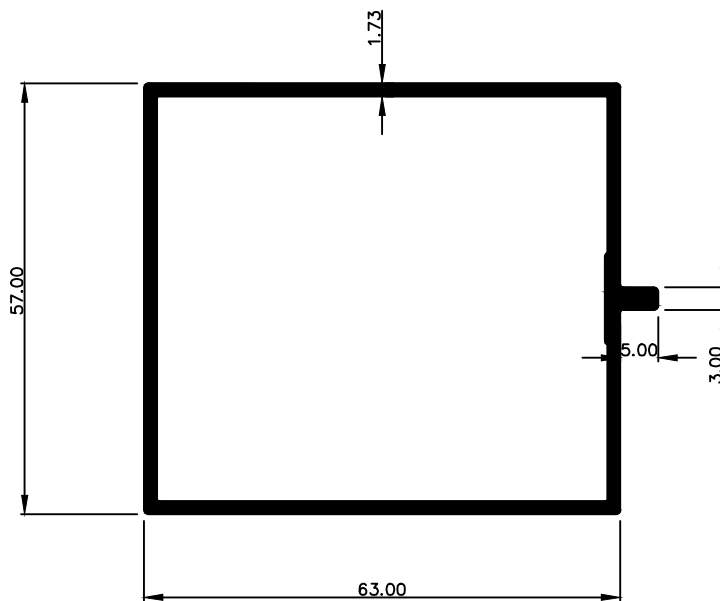

WEIGHT:- 5.500-5.700 kg/16'

3/4" TWO TRACK TOP

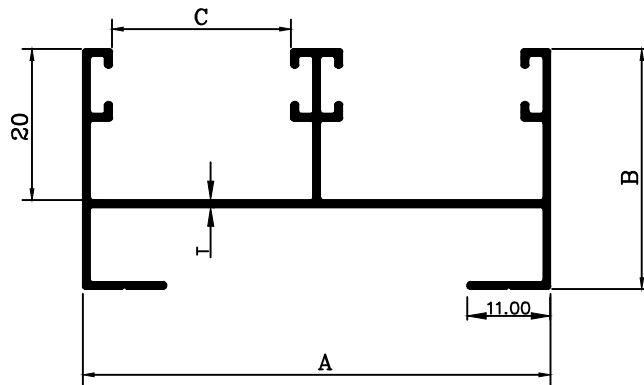

| SEC.No. | C/L | A     | B     | C     | T    | WEIGHT      |
|---------|-----|-------|-------|-------|------|-------------|
| 1331    | 12  | 61.85 | 31.75 | 23.68 | 0.65 | 1.200-1.400 |
| 1332    | 12  | 61.85 | 31.75 | 23.68 | 0.75 | 1.400-1.600 |
| 1333    | 12  | 61.85 | 31.75 | 23.68 | 0.84 | 1.600-1.800 |
| 1334    | 12  | 61.85 | 31.75 | 23.68 | 0.94 | 1.800-2.000 |
| 1335    | 12  | 61.85 | 31.75 | 23.68 | 1.04 | 2.000-2.200 |
| 1336    | 12  | 61.85 | 31.75 | 23.68 | 1.14 | 2.200-2.500 |
| 1337    | 12  | 61.85 | 31.75 | 23.68 | 1.40 | 2.700-2.900 |

3/4" TWO TRACK BOTTOM

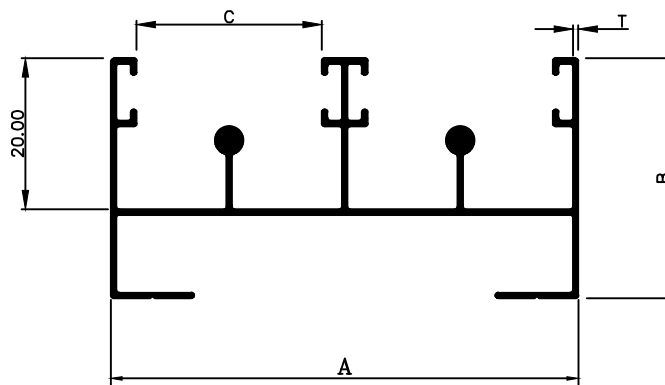

| SEC.No. | C/L | A     | B     | C     | T    | WEIGHT      |
|---------|-----|-------|-------|-------|------|-------------|
| 1351    | 12  | 61.85 | 31.75 | 24.50 | 0.65 | 1.500-1.700 |
| 1352    | 12  | 61.85 | 31.75 | 24.50 | 0.85 | 1.700-1.900 |
| 1353    | 12  | 61.85 | 31.75 | 24.50 | 1.00 | 2.000-2.200 |
| 1354    | 12  | 61.85 | 31.75 | 24.50 | 1.10 | 2.200-2.500 |
| 1355    | 12  | 61.85 | 31.75 | 24.50 | 1.37 | 3.000-3.350 |
| 1356    | 12  | 61.85 | 31.75 | 24.50 | 1.55 | 3.100-3.400 |

### 3/4" THREE TRACK TOP

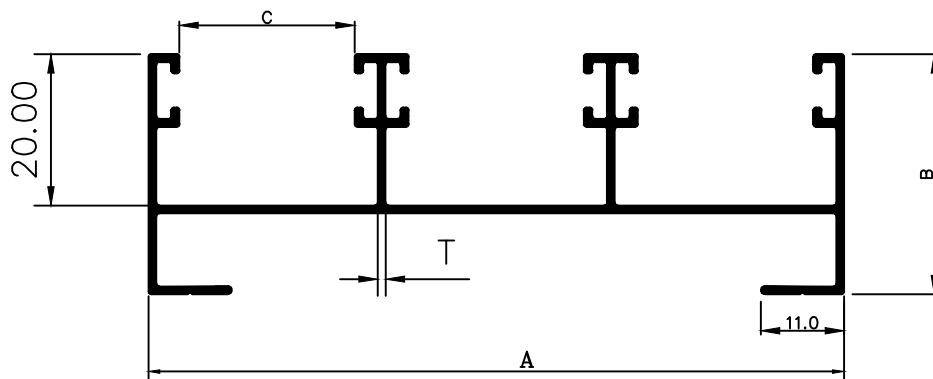

| SEC.No. | C/L | A    | B     | C     | T    | WEIGHT      |
|---------|-----|------|-------|-------|------|-------------|
| 1371    | 12  | 92.0 | 31.75 | 23.20 | 0.65 | 1.800-2.000 |
| 1372    | 12  | 92.0 | 31.75 | 23.20 | 0.72 | 2.000-2.200 |
| 1373    | 12  | 92.0 | 31.75 | 23.20 | 0.87 | 2.400-2.600 |
| 1374    | 12  | 92.0 | 31.75 | 23.20 | 0.98 | 2.700-3.000 |
| 1375    | 12  | 92.0 | 31.75 | 23.20 | 1.30 | 3.400-3.600 |
| 1376    | 12  | 92.0 | 31.75 | 23.20 | 1.50 | 3.700-3.900 |
| 1377    | 12  | 92.0 | 31.75 | 23.20 | 2.00 | 4.500-4.900 |

### 3/4" THREE TRACK BOTTOM

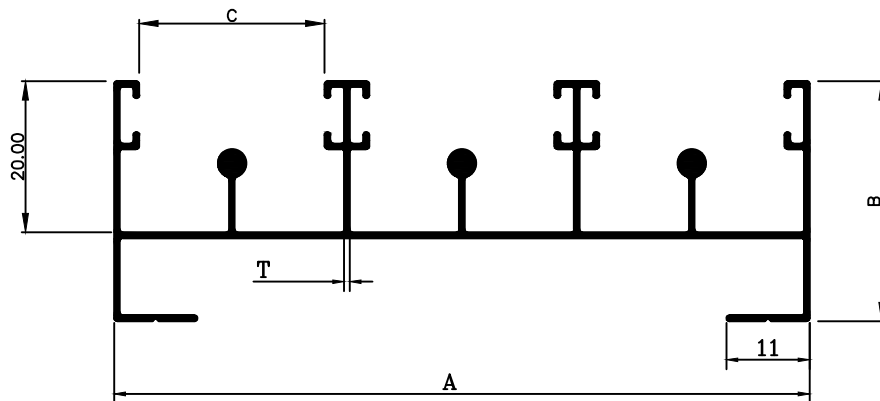

| SEC.No. | C/L | A     | B     | C     | T    | WEIGHT      |
|---------|-----|-------|-------|-------|------|-------------|
| 1391    | 12  | 92.00 | 31.75 | 24.50 | 0.75 | 2.500-2.750 |
| 1392    | 12  | 92.00 | 31.75 | 24.50 | 0.89 | 2.800-3.000 |
| 1393    | 12  | 92.00 | 31.75 | 24.50 | 1.10 | 3.200-3.400 |
| 1394    | 12  | 92.00 | 31.75 | 24.50 | 1.30 | 3.900-4.100 |
| 1395    | 12  | 92.00 | 31.75 | 24.50 | 1.50 | 4.500-4.700 |
| 1396    | 12  | 92.00 | 31.75 | 24.50 | 2.00 | 5.300-5.700 |

### 3/4" FOUR TRACK TOP

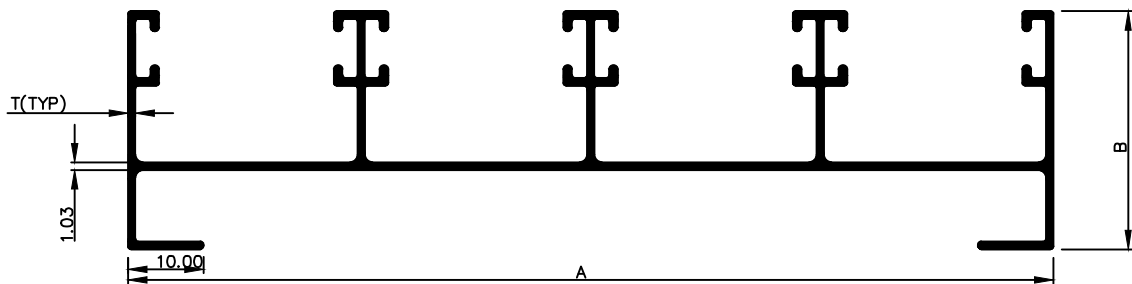

| SEC.No. | A      | B     | T    | Wt.(kg/Mtr.) | Wt.(kg/12') |
|---------|--------|-------|------|--------------|-------------|
| 1411    | 122.40 | 31.50 | 0.97 | 0.901        | 3.300-3.600 |
| 1412    | 122.40 | 31.50 | 1.30 | 1.142        | 4.180-4.500 |
| 1413    | 122.40 | 31.50 | 1.50 | 1.585        | 4.800-5.100 |

### 3/4" FOUR TRACK BOTTOM

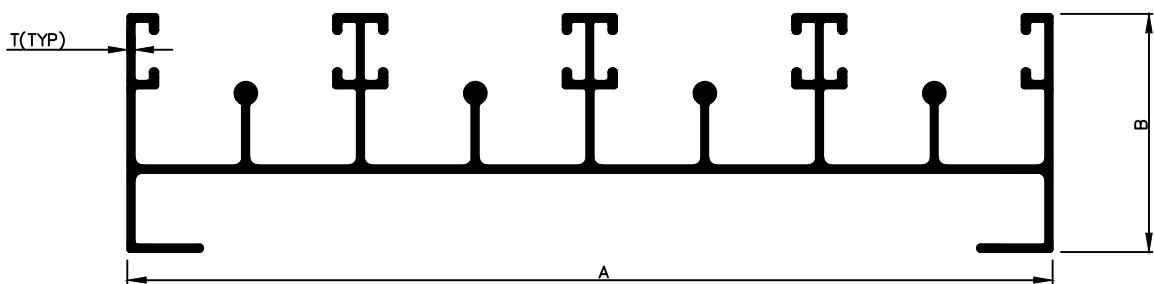

| SEC.No. | A      | B     | T    | Wt.(kg/Mtr.) | Wt.(kg/12') |
|---------|--------|-------|------|--------------|-------------|
| 1421    | 122.40 | 31.50 | 1.00 | 0.928        | 4.000-4.500 |
| 1422    | 122.40 | 31.50 | 1.30 | 1.321        | 4.800-5.200 |
| 1423    | 122.40 | 31.50 | 1.50 | 1.580        | 5.800-6.200 |

### 3/4" FOUR TRACK BOTTOM

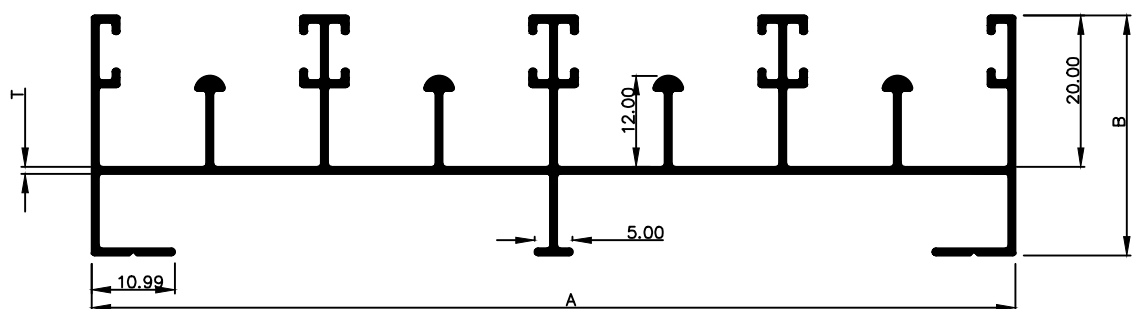

| SEC.No. | A      | B     | T    | Wt.(kg/Mtr.) | Wt.(kg/12') |
|---------|--------|-------|------|--------------|-------------|
| 1431    | 122.40 | 31.50 | 1.00 | 0.928        | 3.850-4.200 |
| 1432    | 122.40 | 31.50 | 1.30 | 1.377        | 5.000-5.400 |
| 1433    | 122.40 | 31.50 | 1.50 | 1.580        | 5.800-6.200 |

SEC. NO:- 1441

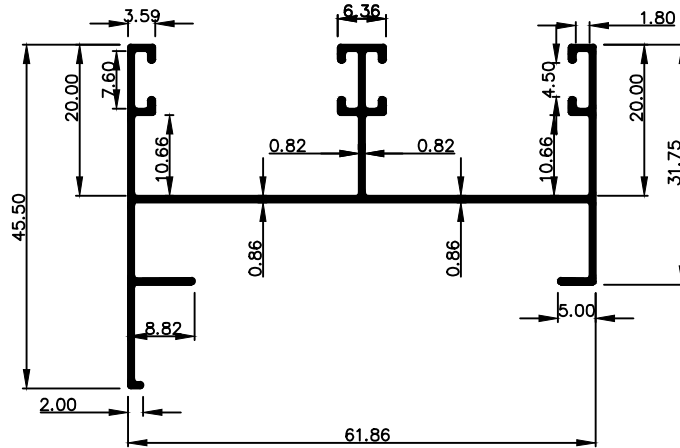

AREA:- 173.773 Sqmm<sup>^</sup>  
 WEIGHT:- 1.717 kg/12'

SEC. NO:- 1446

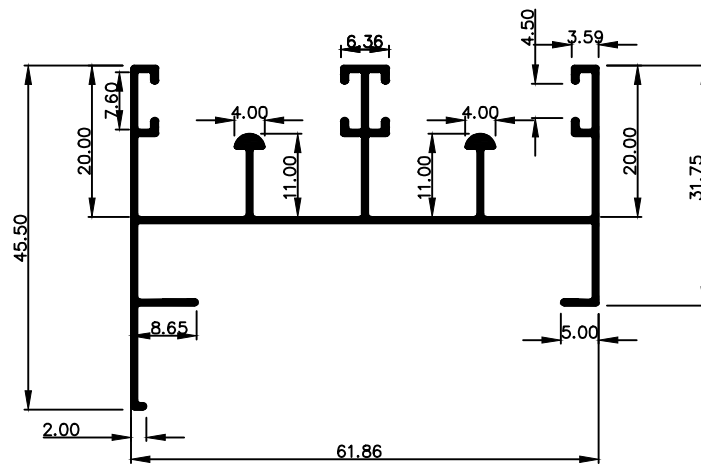

AREA:- 201.398 Sqmm<sup>^</sup>  
 WEIGHT:- 2.000 kg/12'



### 3/4" HANDLE

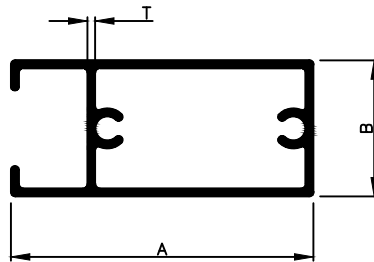

| SEC.No. | C/L | A     | B     | T    | WEIGHT      |
|---------|-----|-------|-------|------|-------------|
| 1461    | 16  | 40.00 | 18.00 | 0.70 | 1.300-1.500 |
| 1462    | 16  | 40.00 | 18.00 | 0.95 | 1.750-1.950 |
| 1463    | 12  | 40.00 | 18.00 | 1.20 | 1.500-1.700 |
| 1464    | 16  | 40.00 | 18.00 | 1.50 | 2.500-2.700 |
| 1465    | 16  | 40.00 | 18.00 | 1.80 | 3.000-3.300 |
|         |     |       |       |      |             |
|         |     |       |       |      |             |

### 3/4" INTERLOCK

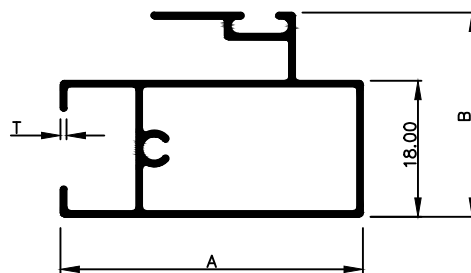

| SEC.No. | C/L | A     | B     | T    | WEIGHT      |
|---------|-----|-------|-------|------|-------------|
| 1491    | 16  | 40.00 | 27.00 | 0.71 | 1.450-1.650 |
| 1492    | 16  | 40.00 | 27.00 | 0.84 | 1.750-1.950 |
| 1493    | 12  | 40.00 | 27.00 | 1.20 | 1.900-2.100 |
| 1494    | 16  | 40.00 | 27.00 | 1.50 | 3.100-3.300 |
| 1495    | 16  | 40.00 | 27.00 | 1.80 | 3.500-3.800 |
|         |     |       |       |      |             |
|         |     |       |       |      |             |

3/4" TOP BOTTOM

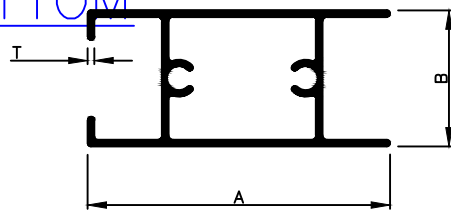

| SEC.No. | C/L | A     | B     | T    | WEIGHT      |
|---------|-----|-------|-------|------|-------------|
| 1511    | 16  | 40.00 | 18.00 | 0.70 | 1.300-1.450 |
| 1512    | 16  | 40.00 | 18.00 | 0.87 | 1.700-1850  |
| 1513    | 16  | 40.00 | 18.00 | 1.50 | 2.600-2.800 |
| 1514    | 16  | 40.00 | 18.00 | 1.80 | 3.000-3.300 |

BEARING BOTTOM

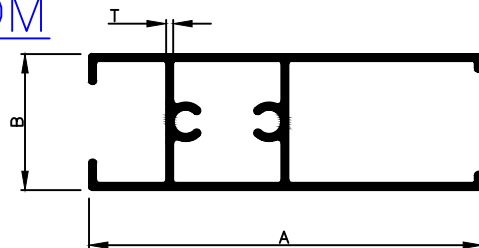

| SEC.No. | C/L | A     | B     | T    | WEIGHT      |
|---------|-----|-------|-------|------|-------------|
| 1530    | 12  | 52.00 | 18.00 | 0.70 | 1.100-1.400 |
| 1531    | 12  | 52.00 | 18.00 | 0.90 | 1.400-1.600 |

MATTING

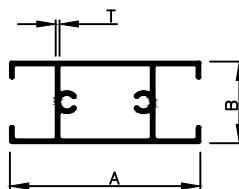

| SEC.No. | C/L | A     | B     | T    | WEIGHT      |
|---------|-----|-------|-------|------|-------------|
| 1540    | 16  | 42.00 | 18.00 | 0.75 | 1.500-1.600 |
| 1542    | 12  | 42.00 | 18.00 | 0.90 | 1.050-1.250 |
| 1541    | 12  | 42.00 | 18.00 | 1.16 | 1.500-1.700 |
|         |     |       |       |      |             |

SINTEX – ” A ”

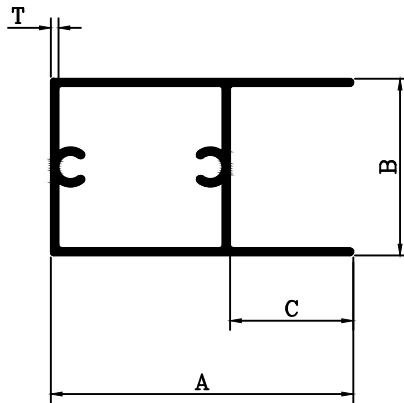

| SEC.No. | C/L | A     | B     | C     | T    | WT. RANGE   |
|---------|-----|-------|-------|-------|------|-------------|
| 1551    | 16' | 40.00 | 23.60 | 16.30 | 1.00 | 1.800–2.000 |

SINTEX – ” H ”

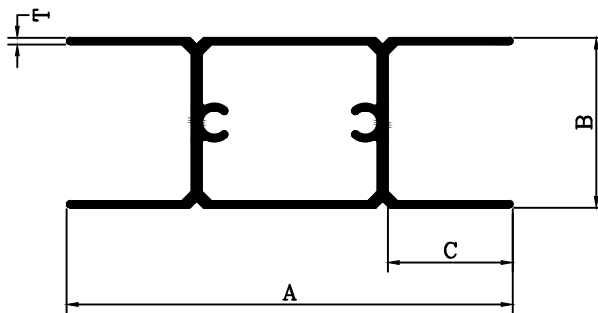

| SEC.No. | C/L | A     | B     | C     | T    | WT. RANGE   |
|---------|-----|-------|-------|-------|------|-------------|
| 1556    | 12' | 60.00 | 23.00 | 16.50 | 0.84 | 1.500–1.700 |

20 mm TWO TRACK TOP

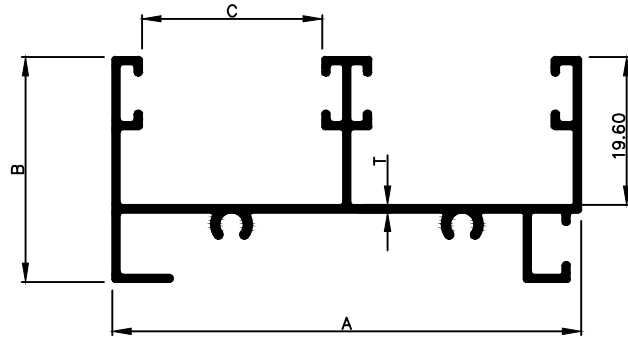

| SEC.No. | C/L | A     | B     | C     | T    | WEIGHT      |
|---------|-----|-------|-------|-------|------|-------------|
| 1560    | 16  | 62.00 | 29.50 | 23.80 | 0.70 | 2.100-2.200 |
| 1561    | 16  | 62.00 | 29.50 | 23.80 | 0.85 | 2.400-2.600 |
| 1562    | 16  | 62.00 | 29.50 | 23.40 | 1.10 | 2.800-3.000 |
| 1563    | 16  | 62.00 | 29.50 | 23.80 | 1.50 | 4.000-4.200 |
| 1564    | 16  | 62.00 | 29.50 | 23.80 | 1.65 | 4.500-4.800 |
| 1565    | 16  | 62.00 | 29.50 | 23.80 | 2.00 | 4.800-5.000 |

20 mm TWO TRACK BOTTOM

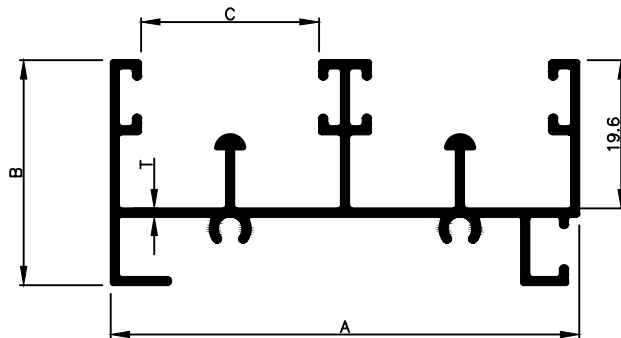

| SEC.No. | C/L | A     | B     | C     | T    | WEIGHT      |
|---------|-----|-------|-------|-------|------|-------------|
| 1581    | 16  | 62.00 | 29.50 | 23.80 | 0.80 | 2.450-2.650 |
| 1582    | 16  | 62.00 | 29.50 | 23.40 | 1.05 | 2.800-3.100 |
| 1583    | 16  | 62.00 | 29.50 | 23.80 | 1.50 | 4.500-4.900 |
| 1584    | 16  | 62.00 | 29.50 | 23.80 | 1.65 | 5.000-5.500 |
| 1585    | 16  | 62.00 | 29.50 | 23.80 | 2.00 | 5.300-5.800 |

20 mm THREE TRACK TOP

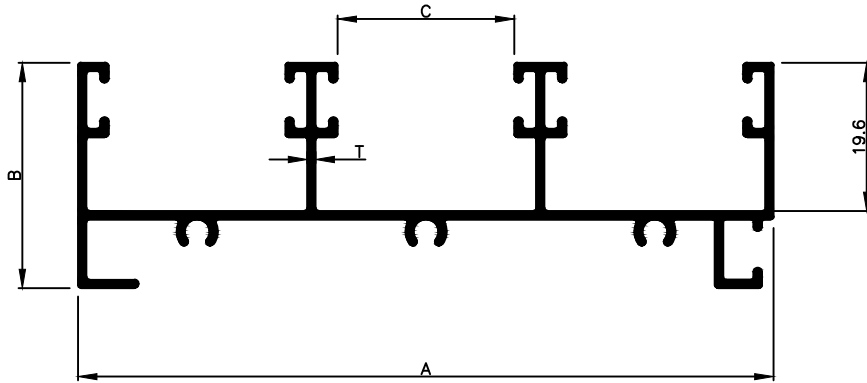

| SEC.No. | C/L | A     | B     | C     | T    | WEIGHT      |
|---------|-----|-------|-------|-------|------|-------------|
| 1600    | 16  | 92.00 | 29.50 | 23.50 | 0.72 | 3.100-3.400 |
| 1601    | 16  | 92.00 | 29.50 | 23.50 | 0.95 | 3.600-3.800 |
| 1603    | 16  | 92.00 | 29.50 | 22.70 | 1.10 | 4.100-4.400 |
| 1602    | 16  | 92.00 | 29.50 | 22.13 | 1.50 | 5.200-5.600 |

20 mm THREE TRACK BOTTOM

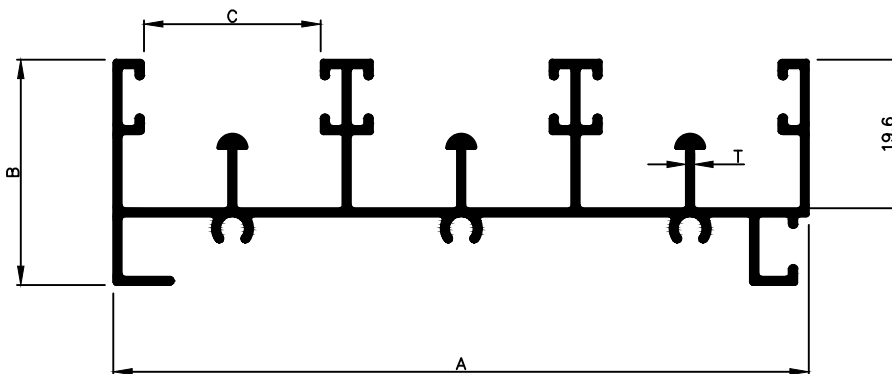

| SEC.No. | C/L | A     | B     | C     | T    | WEIGHT      |
|---------|-----|-------|-------|-------|------|-------------|
| 1620    | 16  | 92.00 | 29.50 | 23.50 | 0.70 | 3.300-3.800 |
| 1621    | 16  | 92.00 | 29.50 | 23.50 | 0.95 | 3.800-4.000 |
| 1623    | 16  | 92.00 | 29.50 | 22.70 | 1.10 | 4.400-4.700 |
| 1622    | 16  | 92.00 | 29.50 | 22.13 | 1.50 | 6.000-6.500 |

20 mm FOUR TRACK TOP

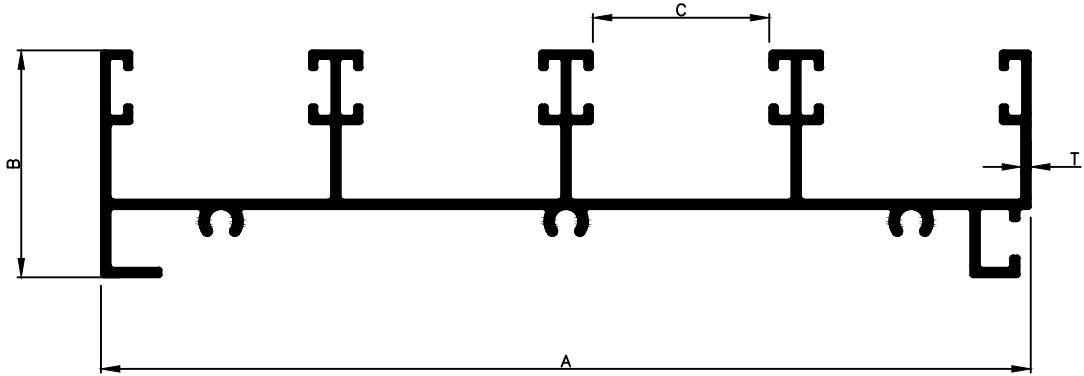

| SEC.No. | C/L | A     | B     | C     | T    | WEIGHT      |
|---------|-----|-------|-------|-------|------|-------------|
| 1631    | 16  | 123.0 | 30.00 | 23.35 | 1.27 | 5.650-5.850 |
|         |     |       |       |       |      |             |
|         |     |       |       |       |      |             |
|         |     |       |       |       |      |             |

20 mm FOUR TRACK BOTTOM

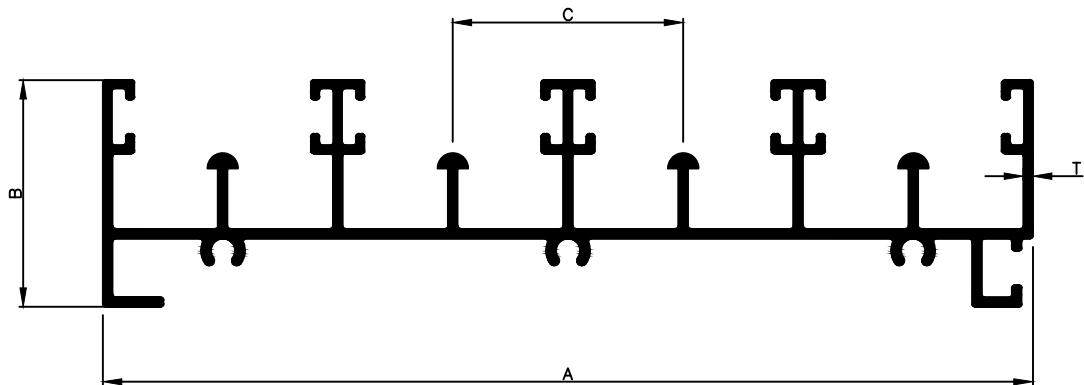

| SEC.No. | C/L | A     | B     | C     | T    | WEIGHT      |
|---------|-----|-------|-------|-------|------|-------------|
| 1636    | 16  | 123.0 | 30.00 | 30.45 | 1.27 | 6.550-6.750 |
|         |     |       |       |       |      |             |
|         |     |       |       |       |      |             |
|         |     |       |       |       |      |             |

20mm HANDLE

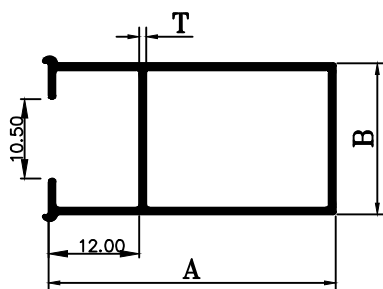

| SEC.No. | C/L | A     | B     | T    | WEIGHT      |
|---------|-----|-------|-------|------|-------------|
| 1641    | 12  | 38.00 | 20.00 | 0.92 | 1.100-1.300 |
| 1642    | 12  | 38.00 | 20.00 | 1.00 | 1.200-1.400 |
| 1645    | 12  | 38.00 | 20.00 | 1.20 | 1.500-1.700 |
| 1643    | 12  | 38.00 | 20.00 | 1.50 | 1.700-1.900 |
| 1644    | 12  | 38.00 | 20.00 | 1.65 | 1.900-2.100 |

20mm INTERLOCK

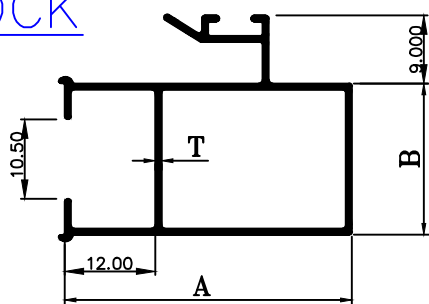

| SEC.No. | C/L | A     | B     | T    | WEIGHT      |
|---------|-----|-------|-------|------|-------------|
| 1651    | 12  | 38.00 | 20.00 | 0.82 | 1.200-1.400 |
| 1655    | 12  | 38.00 | 20.00 | 1.00 | 1.400-1.600 |
| 1652    | 12  | 38.00 | 20.00 | 1.20 | 1.700-1.900 |
| 1653    | 12  | 38.00 | 20.00 | 1.50 | 2.000-2.200 |
| 1654    | 12  | 38.00 | 20.00 | 1.65 | 2.300-2.500 |

20mm TOP BOTTOM

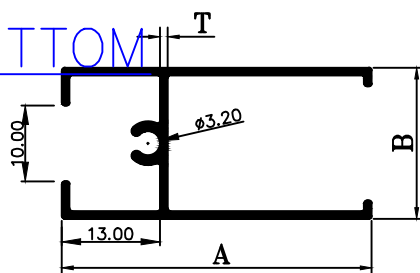

| SEC.No. | C/L | A     | B     | T    | WEIGHT      |
|---------|-----|-------|-------|------|-------------|
| 1661    | 12  | 41.00 | 20.00 | 0.85 | 1.000-1.200 |
| 1665    | 12  | 41.00 | 20.00 | 1.00 | 1.200-1.400 |
| 1663    | 12  | 41.00 | 20.00 | 1.20 | 1.400-1.600 |
| 1662    | 12  | 41.00 | 20.00 | 1.50 | 1.700-1.900 |
| 1664    | 12  | 41.00 | 20.00 | 1.65 | 2.000-2.300 |

1" TWO TRACK TOP

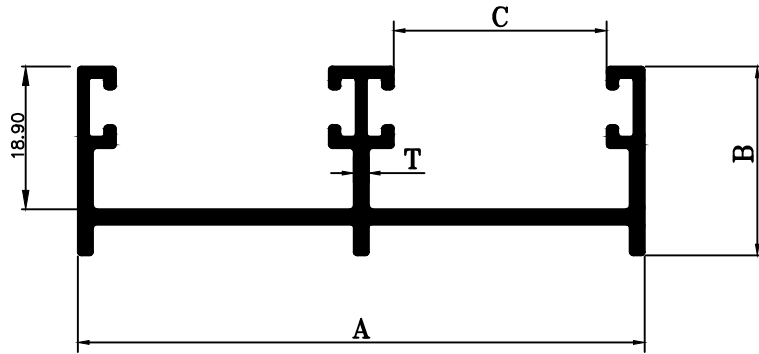

| SEC.No. | C/L | A     | B     | C     | T    | WEIGHT      |
|---------|-----|-------|-------|-------|------|-------------|
| 1671    | 12  | 75.00 | 25.00 | 28.20 | 2.00 | 3.300-3.500 |

1" TWO TRACK BOTTOM

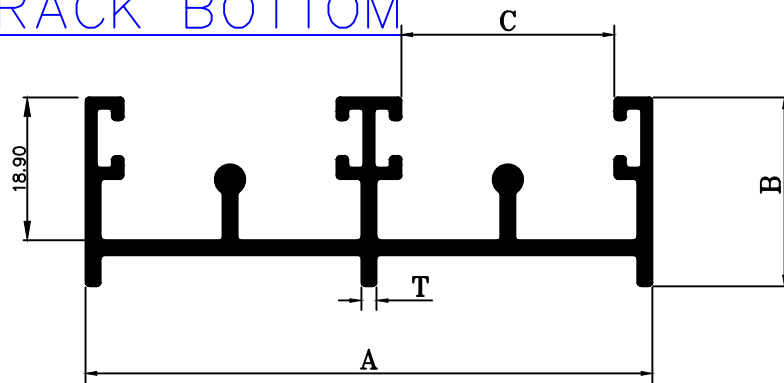

| SEC.No. | C/L | A     | B     | C     | T    | WEIGHT      |
|---------|-----|-------|-------|-------|------|-------------|
| 1681    | 12  | 75.00 | 25.00 | 28.20 | 2.00 | 3.800-4.000 |

1" TWO TRACK BOTTOM HOLLOW

SEC. NO:- 1691

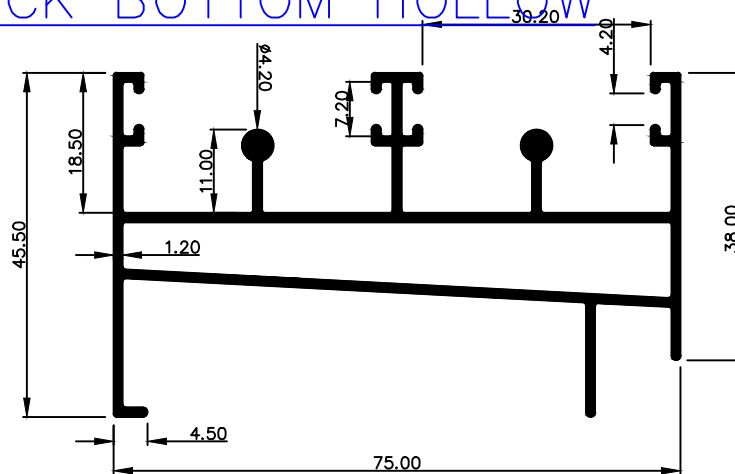

WEIGHT: 4.000-4.300 kg/12'

1" THREE TRACK TOP

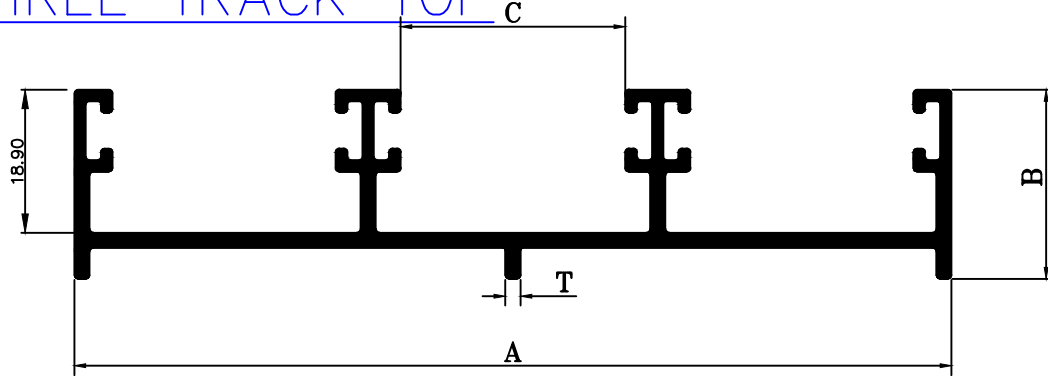

| SEC.No. | C/L | A     | B     | C     | T    | WEIGHT      |
|---------|-----|-------|-------|-------|------|-------------|
| 1702    | 12  | 116.0 | 25.00 | 29.70 | 1.45 | 3.700-4.000 |
| 1701    | 12  | 116.0 | 25.00 | 29.70 | 2.00 | 4.700-5.000 |

1" THREE TRACK BOTTOM

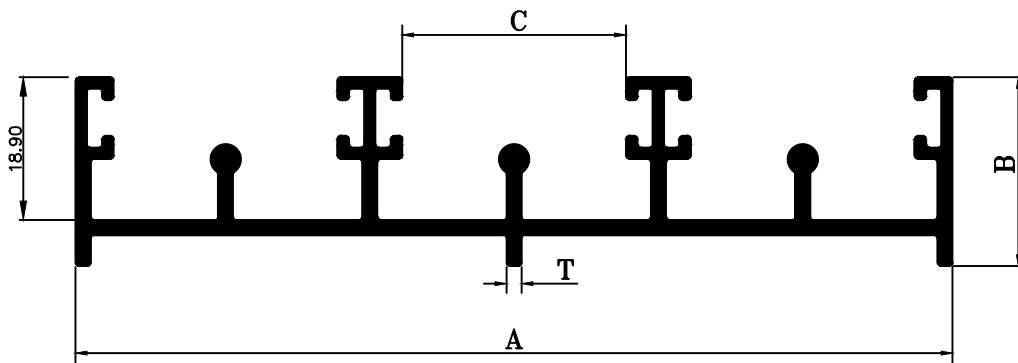

| SEC.No. | C/L | A     | B     | C     | T    | WEIGHT      |
|---------|-----|-------|-------|-------|------|-------------|
| 1712    | 12  | 116.0 | 25.00 | 29.60 | 1.47 | 4.500-4.800 |
| 1711    | 12  | 116.0 | 25.00 | 29.60 | 2.00 | 5.500-5.800 |

1" THREE TRACK BOTTOM HOLLOW

SEC. NO:- 1721

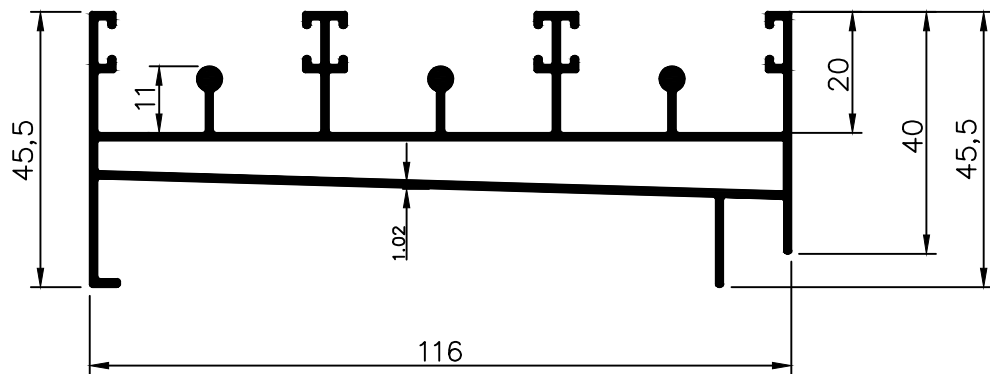

WEIGHT: 5.800-6.200 kg/12'

SINGLE GLASS CHANNEL

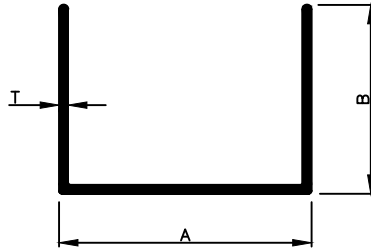

| SEC.No. | C/L | A     | B     | T    | WEIGHT      |
|---------|-----|-------|-------|------|-------------|
| 2301    | 12  | 9.52  | 9.52  | 0.52 | 0.140-0.170 |
| 2302    | 12  | 9.52  | 9.52  | 0.72 | 0.180-0.220 |
| 2303    | 12  | 12.50 | 12.50 | 0.55 | 0.180-0.220 |
| 2306    | 12  | 12.50 | 12.50 | 0.65 | 0.220-0.250 |
| 2304    | 12  | 28.40 | 25.00 | 1.20 | 0.900-9.500 |
| 2305    | 12  | 33.40 | 25.00 | 1.20 | 0.950-1.000 |

SEC.No.-2251

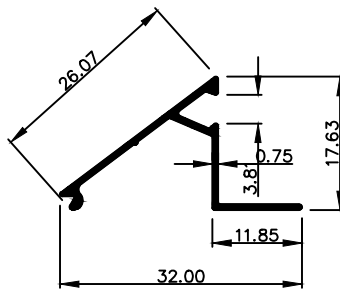

WEIGHT:-0.450-0.480 kg/12'

1" HANDLE

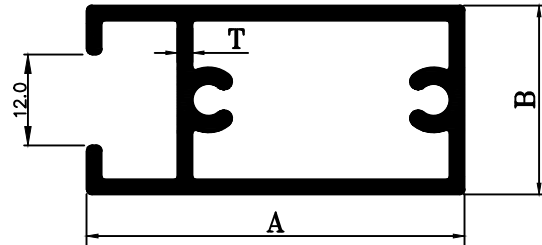

| SEC.No. | C/L | A     | B     | T    | WEIGHT      |
|---------|-----|-------|-------|------|-------------|
| 1740    | 15  | 44.00 | 25.40 | 0.82 | 1.700-2.000 |
| 1741    | 15  | 50.00 | 25.00 | 0.85 | 1.800-2.100 |
| 1742    | 12  | 50.00 | 25.00 | 1.20 | 2.100-2.300 |
| 1743    | 12  | 50.00 | 25.00 | 1.30 | 2.260-2.400 |
| 1744    | 12  | 50.00 | 25.00 | 1.40 | 2.400-2.600 |
| 1745    | 12  | 50.00 | 25.00 | 1.50 | 2.600-2.800 |
| 1746    | 12  | 50.00 | 25.00 | 2.00 | 3.400-3.700 |

1" INTERLOCK

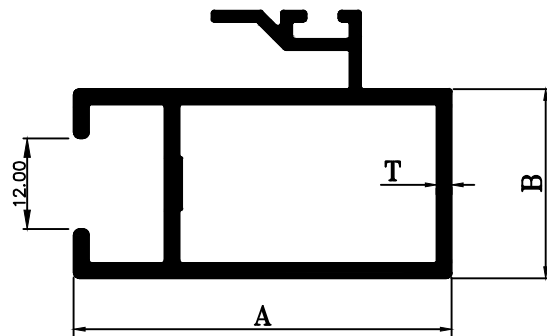

| SEC.No. | C/L | A     | B     | T    | WEIGHT      |
|---------|-----|-------|-------|------|-------------|
| 1760    | 12  | 50.00 | 25.00 | 0.75 | 1.600-1.900 |
| 1765    | 12  | 50.00 | 25.00 | 1.12 | 2.150-2.250 |
| 1761    | 12  | 50.00 | 25.00 | 1.20 | 2.300-2.400 |
| 1762    | 12  | 50.00 | 25.00 | 1.30 | 2.400-2.600 |
| 1763    | 12  | 50.00 | 25.00 | 1.50 | 2.800-3.100 |
| 1764    | 12  | 50.00 | 25.00 | 2.00 | 3.500-3.750 |
|         |     |       |       |      |             |

1" TOP BOTTOM

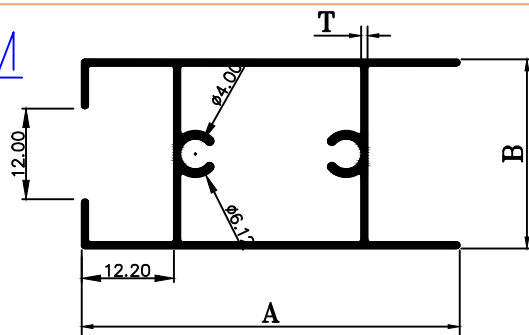

| SEC.No. | C/L | A     | B     | T    | WEIGHT      |
|---------|-----|-------|-------|------|-------------|
| 1783    | 15  | 50.00 | 25.40 | 0.82 | 1.700-2.000 |
| 1781    | 15  | 50.00 | 25.00 | 0.85 | 1.800-2.100 |
| 1782    | 15  | 50.00 | 25.00 | 1.00 | 2.200-2.500 |
| 1780    | 15  | 45.00 | 25.00 | 1.10 | 2.300-2.500 |

BEARING BOTTOM

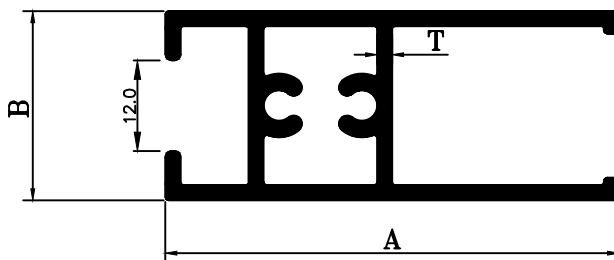

| SEC.No. | C/L | A     | B     | T    | WEIGHT      |
|---------|-----|-------|-------|------|-------------|
| 1791    | 12  | 60.00 | 25.00 | 1.01 | 2.400-2.600 |
| 1792    | 12  | 60.00 | 25.00 | 1.32 | 2.600-2.800 |
| 1793    | 12  | 60.00 | 25.00 | 2.00 | 3.800-4.100 |

MATTING

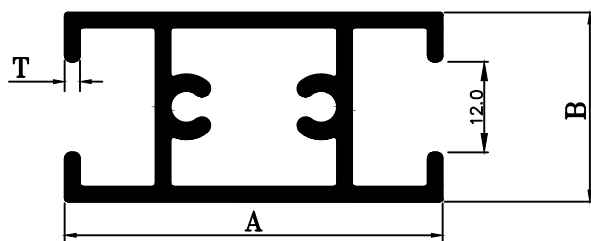

| SEC.No. | C/L | A     | B     | T    | WEIGHT      |
|---------|-----|-------|-------|------|-------------|
| 1801    | 12  | 50.00 | 25.00 | 0.85 | 1.600-1.800 |
| 1802    | 12  | 50.00 | 25.00 | 1.10 | 1.900-2.150 |
| 1803    | 12  | 50.00 | 25.00 | 1.30 | 2.300-2.500 |
| 1804    | 12  | 50.00 | 25.00 | 1.50 | 2.700-2.900 |
| 1805    | 12  | 50.00 | 25.00 | 2.00 | 3.500-3.750 |

SEC.No.-1821

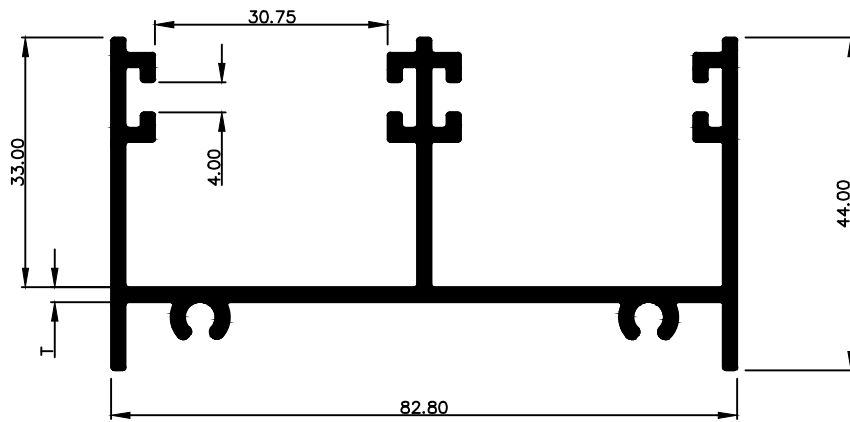

| SEC.No. | C/L | T    | WEIGHT      |
|---------|-----|------|-------------|
| 1822    | 12  | 1.30 | 3.400-3.800 |
| 1821    | 12  | 2.00 | 5.000-5.400 |
|         |     |      |             |

SEC.No.-1831

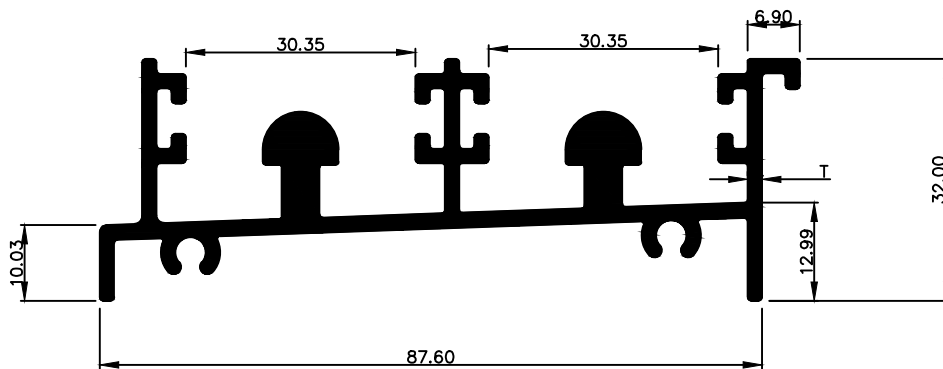

| SEC.No. | C/L | T    | WEIGHT      |
|---------|-----|------|-------------|
| 1832    | 12  | 1.40 | 4.600-5.000 |
| 1831    | 12  | 1.90 | 6.400-6.800 |
|         |     |      |             |

SEC.No.-1841

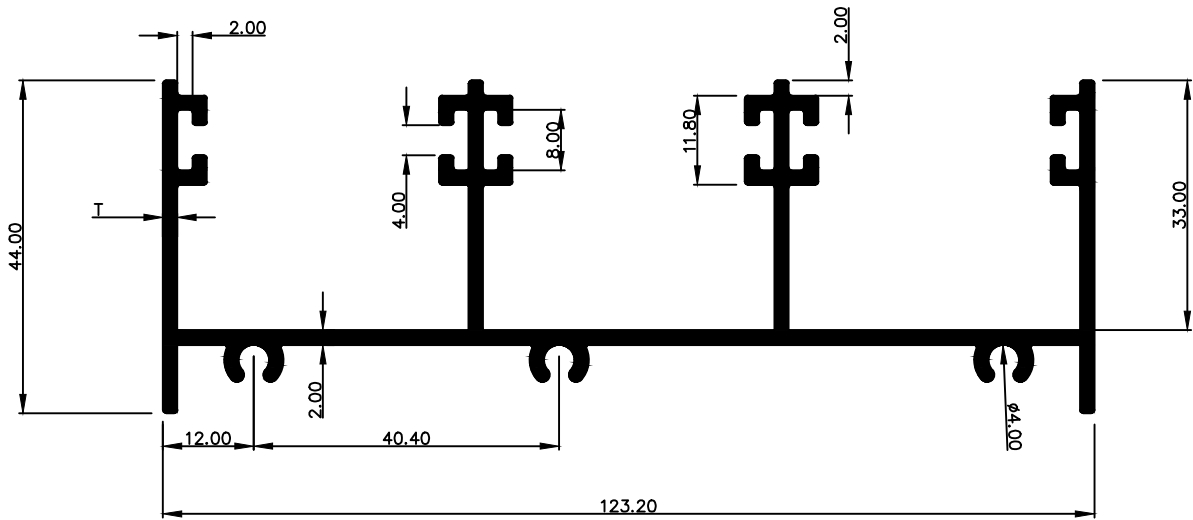

| SEC.No. | C/L | T    | WEIGHT      |
|---------|-----|------|-------------|
| 1841    | 12  | 1.90 | 7.000-7.500 |
| 1842    | 12  | 1.33 | 5.000-5.500 |
| 1843    | 12  | 1.20 | 4.500-5.000 |

SEC.No.-1851

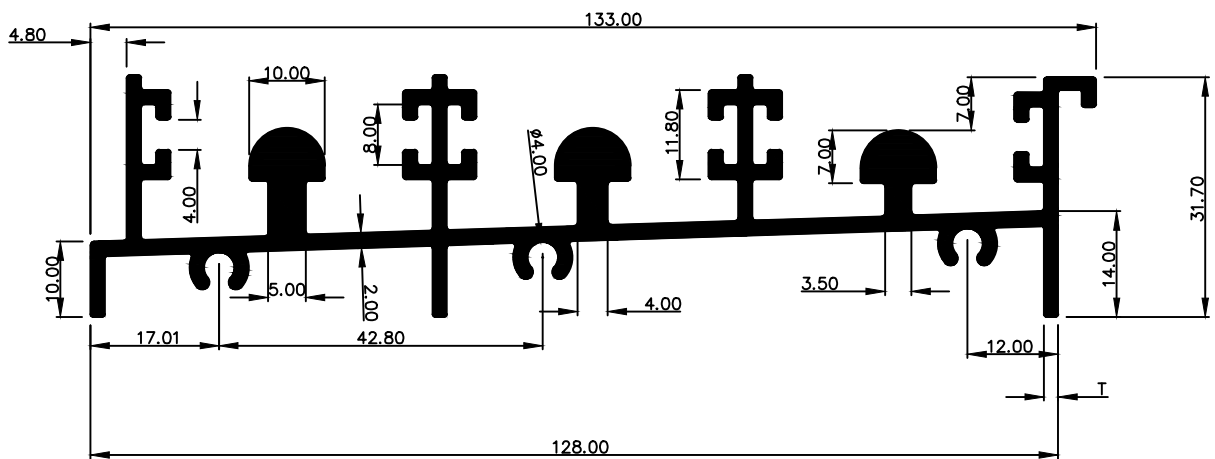

| SEC.No. | C/L | T    | WEIGHT      |
|---------|-----|------|-------------|
| 1851    | 12  | 1.90 | 9.000-9.500 |
| 1852    | 12  | 1.40 | 7.400-7.700 |
| 1853    | 12  | 1.20 | 6.600-7.100 |

SEC. NO:- 1856

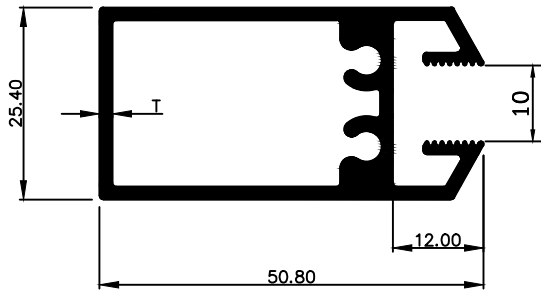

| SEC.No. | C/L | T    | WEIGHT      |
|---------|-----|------|-------------|
| 1857    | 12  | 1.00 | 2.500-2.800 |
| 1856    | 12  | 1.70 | 3.200-3.400 |

SEC. NO:- 1861

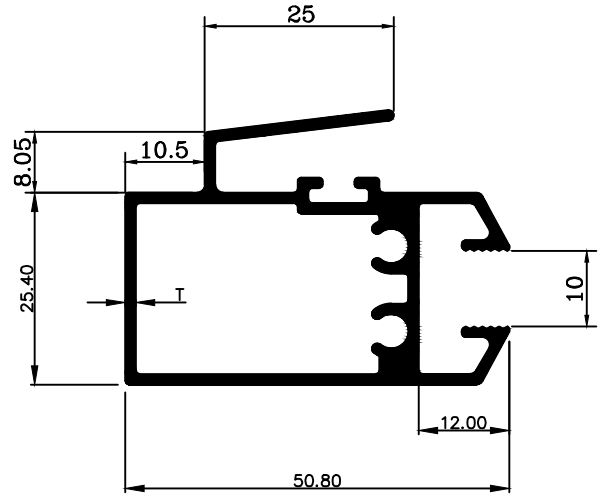

| SEC.No. | C/L | T    | WEIGHT      |
|---------|-----|------|-------------|
| 1862    | 12  | 1.30 | 3.100-3.300 |
| 1861    | 12  | 1.40 | 3.300-3.500 |

SEC. NO:- 1866

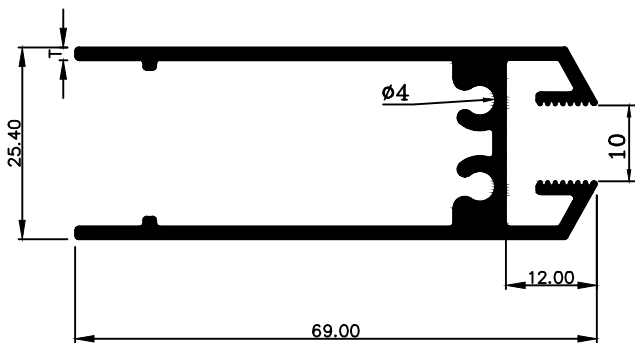

| SEC.No. | C/L | T    | WEIGHT      |
|---------|-----|------|-------------|
| 1867    | 12  | 1.35 | 3.000-3.200 |
| 1866    | 12  | 1.70 | 3.500-3.700 |

SEC. NO:- 1871

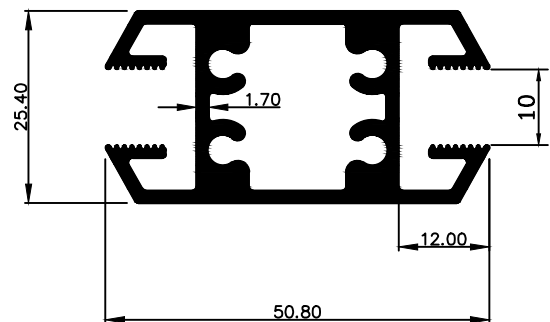

WEIGHT: 4.100-4.300 kg/12'

SEC.No.- 1876

60 X 18 HANDLE

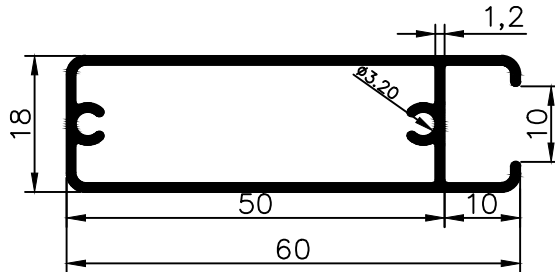

WEIGHT:- 2.000 kg/12'

SEC.No.- 1881

60 X 18 INTERLOCK

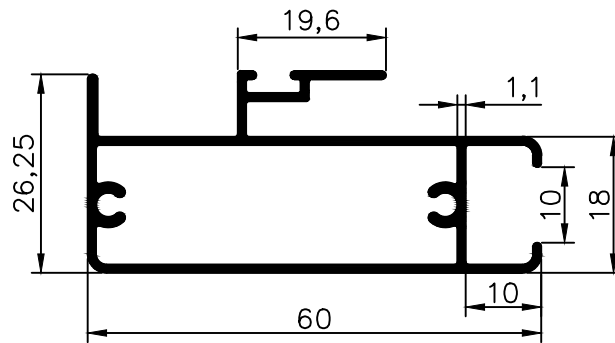

WEIGHT:- 2.350 kg/12'

SEC.No.- 1886

60 X 18 TOP BOTTOM

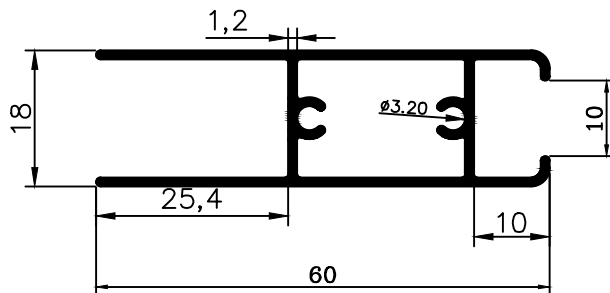

WEIGHT:- 2.000 kg/12'

L-TUBE

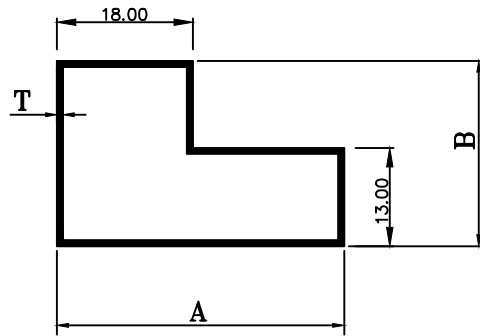

| SEC.No. | C/L | A     | B     | T    | WEIGHT      |
|---------|-----|-------|-------|------|-------------|
| 1891    | 12  | 38.00 | 24.50 | 0.85 | 0.950-1.050 |
| 1892    | 12  | 38.00 | 24.50 | 0.90 | 1.050-1.150 |
| 1894    | 12  | 38.00 | 25.00 | 1.45 | 1.700-1.900 |
| 1893    | 12  | 50.00 | 25.00 | 1.10 | 1.300-1.500 |
|         |     |       |       |      |             |
|         |     |       |       |      |             |
|         |     |       |       |      |             |

'L' TUBE WITH GROOVE

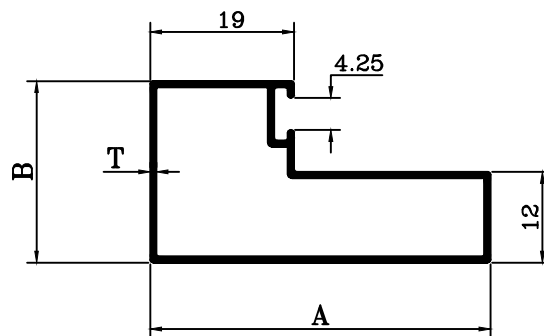

| SEC.No. | C/L | A     | B     | T    | WEIGHT      |
|---------|-----|-------|-------|------|-------------|
| 1901    | 12  | 45.00 | 24.00 | 0.82 | 1.100-1.300 |
| 1902    | 12  | 45.00 | 24.00 | 1.10 | 1.500-1.700 |
| 1903    | 12  | 45.00 | 24.00 | 1.50 | 2.000-2.300 |
|         |     |       |       |      |             |
|         |     |       |       |      |             |
|         |     |       |       |      |             |

2 1/2 X 1 1/2 L-TUBE

SEC.No.-1911

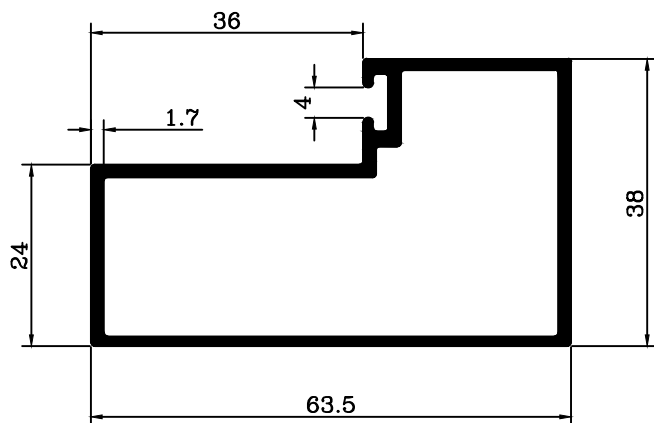

WEIGHT:-4.000 kg/16'

MOULDING CHOKHAT

SEC.No.-1912

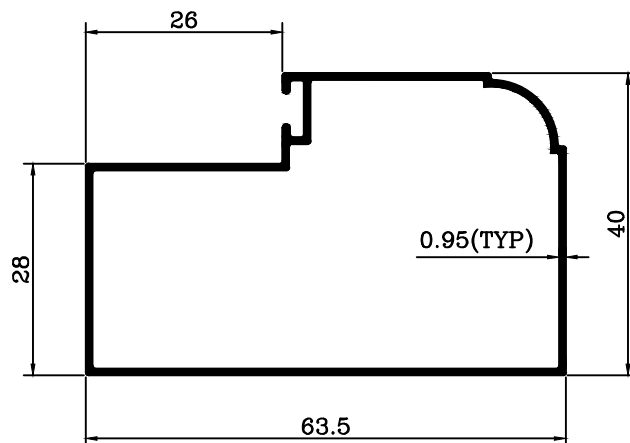

WEIGHT:-2.650-2.850kg/16'

CORNER PARTITION

SEC.No.-1913

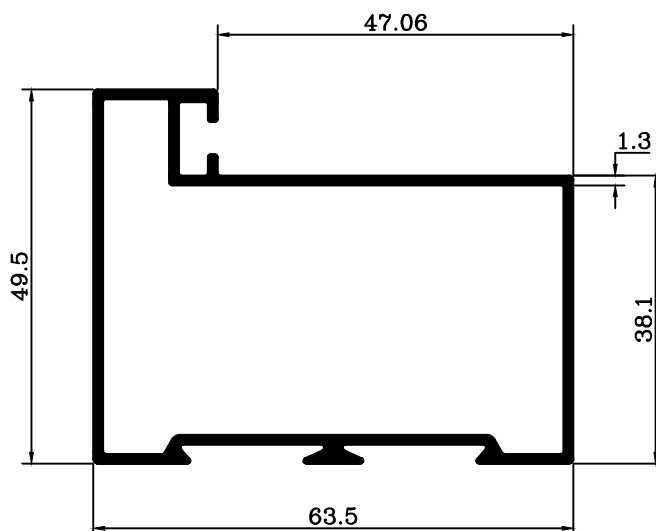

WEIGHT:-3.700-4.000 kg/16'

CURTAIN WALL

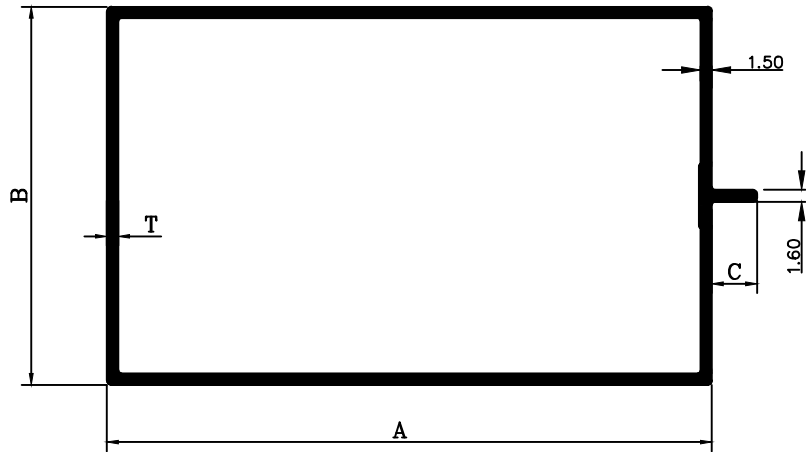

| SEC.No. | C/L | A     | B     | C     | T    | WT. RANGE   |
|---------|-----|-------|-------|-------|------|-------------|
| 1921    | 15' | 80.00 | 50.00 | 6.000 | 1.50 | 4.800-5.100 |
|         |     |       |       |       |      |             |
|         |     |       |       |       |      |             |

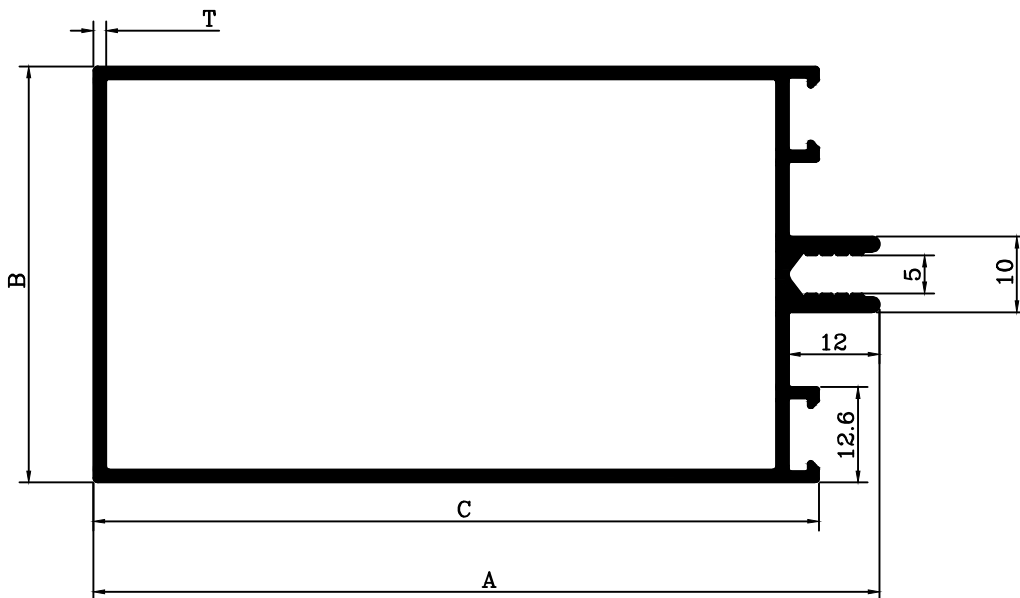

| SEC.No. | C/L | A     | B     | C     | T    | WT. RANGE   |
|---------|-----|-------|-------|-------|------|-------------|
| 1931    | 16' | 104.0 | 55.00 | 96.00 | 1.70 | 7.500-8.500 |
| 1932    | 16' | 104.0 | 55.00 | 96.00 | 2.00 | 8.500-9.500 |
| 1933    | 16' | 75.0  | 55.00 | 67.00 | 1.70 | 4.700-5.200 |

COVER PLATE

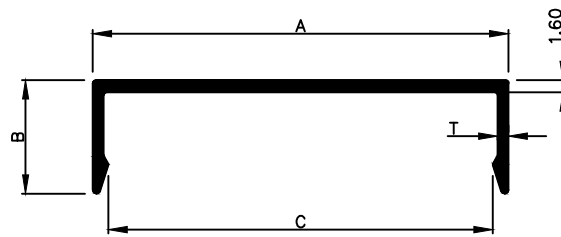

| SEC.No. | C/L | A     | B     | C     | T    | WT. RANGE   |
|---------|-----|-------|-------|-------|------|-------------|
| 1936    | 15' | 55.00 | 15.00 | 50.85 | 1.45 | 1.500-1.700 |

PRESSURE PLATE

SEC. NO:- 1943

VP-332

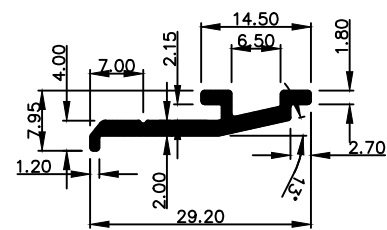
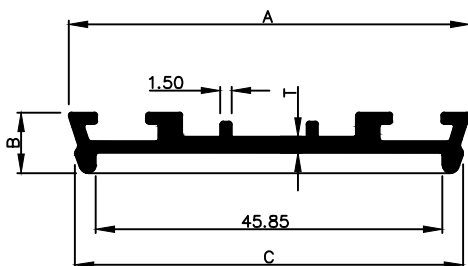

WEIGHT:- 0.700-0.900 Kg/12'

| SEC.No. | C/L | A     | B     | C     | T    | WT. RANGE   |
|---------|-----|-------|-------|-------|------|-------------|
| 1941    | 15' | 53.00 | 8.000 | 51.35 | 2.10 | 1.900-2.100 |

SEC. NO:-1946

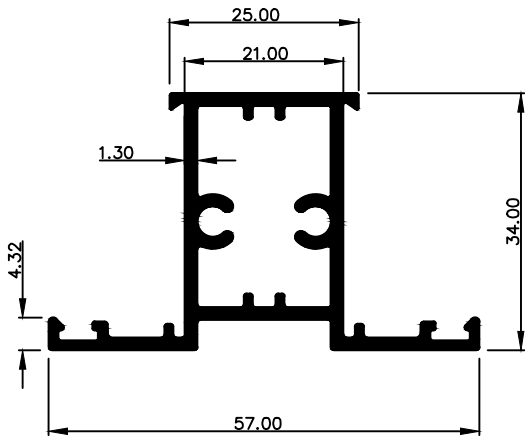

WEIGHT:- 2.100-2.400 kg/12'

SEC. NO:-1951

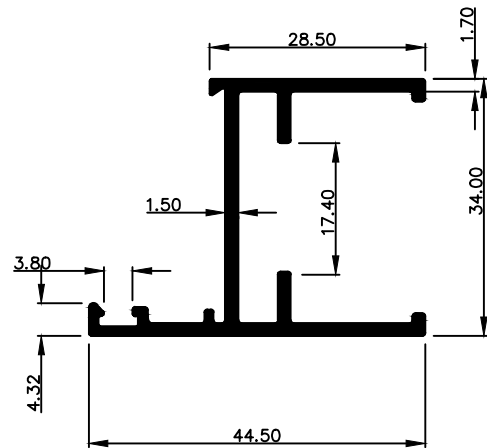

WEIGHT:- 2.100-2.300 kg/12'

SEC. NO:- 1956

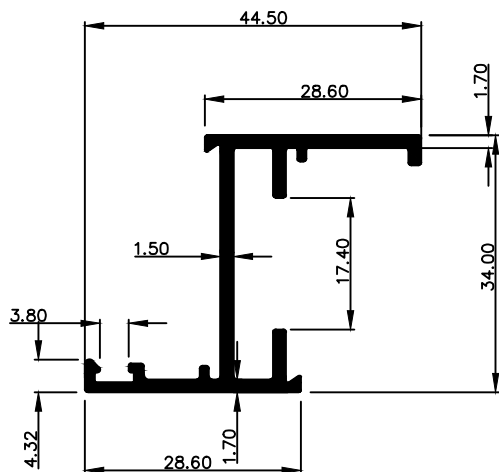

WEIGHT:- 1.500-1.800 kg/12'

SEC. NO:- 1961

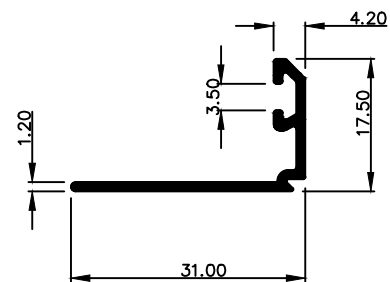

WEIGHT:- 0.650-0.700 kg/12'

## SEC. NO:- 1966

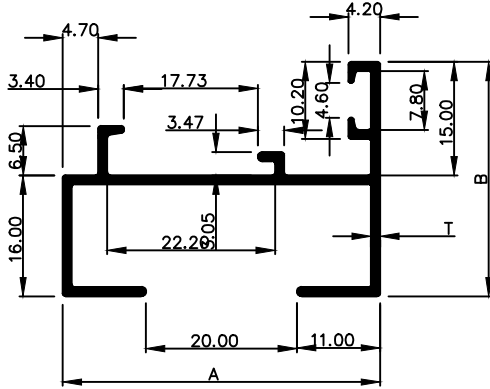

| SEC.No. | A     | B     | T    | Wt.(kg/12') |
|---------|-------|-------|------|-------------|
| 1966    | 42.00 | 31.00 | 1.20 | 1.500-1.800 |
| 1967    | 42.00 | 31.00 | 1.50 | 1.800-2.100 |

## SEC. NO:- 1971

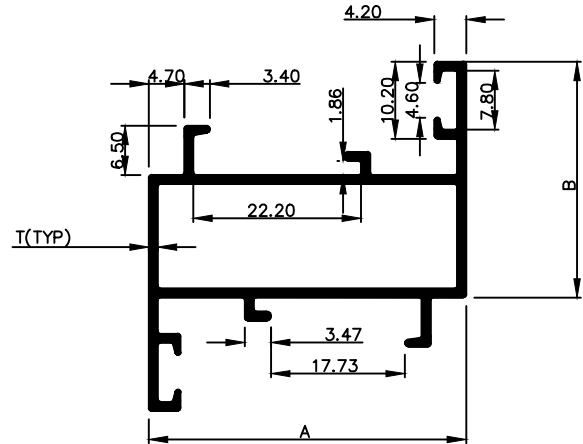

| SEC.No. | A     | B     | T    | Wt.(kg/12') |
|---------|-------|-------|------|-------------|
| 1971    | 42.00 | 31.20 | 1.20 | 2.200-2.400 |
| 1972    | 42.00 | 31.20 | 1.50 | 2.650-2.950 |

## SEC. NO:- 1976

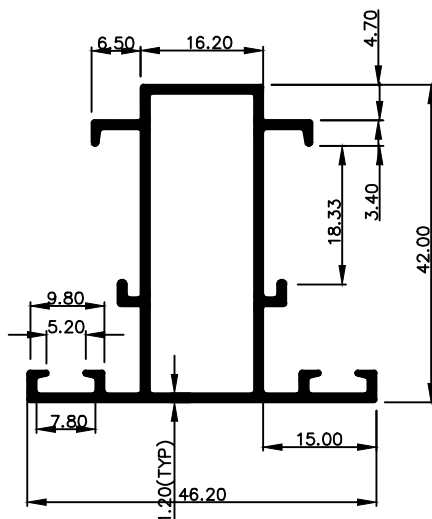

| SEC.No. | A     | B     | T    | Wt.(kg/12') |
|---------|-------|-------|------|-------------|
| 1976    | 46.20 | 42.00 | 1.20 | 2.190-2.390 |
| 1977    | 46.20 | 42.00 | 1.50 | 2.650-2.950 |

## SEC. NO:- 1981

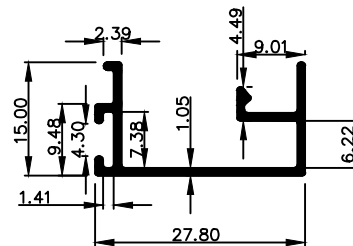

| SEC.No. | A     | B     | T    | Wt.(kg/12') |
|---------|-------|-------|------|-------------|
| 1981    | 27.80 | 15.00 | 1.05 | 0.770-0.870 |
| 1982    | 27.80 | 15.00 | 1.50 | 1.000-1.200 |

MULLION 40 mm SERIES

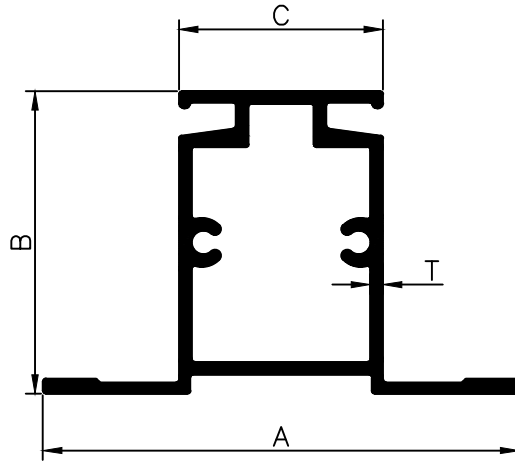

| SEC.No. | C/L | A     | B     | C     | T    | WT. RANGE   |
|---------|-----|-------|-------|-------|------|-------------|
| 1985    | 12' | 63.00 | 40.00 | 27.00 | 1.40 | 2.700-3.000 |
| 1986    | 12' | 63.00 | 40.00 | 27.00 | 1.70 | 3.300-3.500 |

SHUTTER FRAME 40 mm SERIES

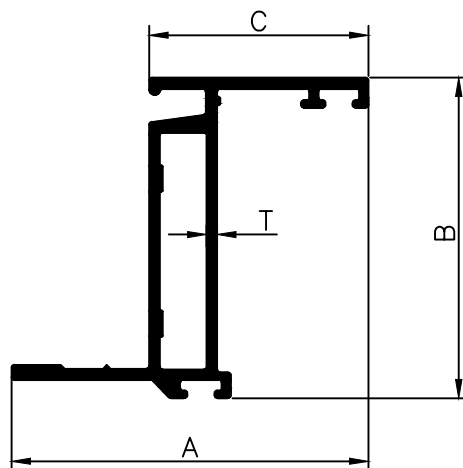

| SEC.No. | C/L | A     | B     | C     | T    | WT. RANGE   |
|---------|-----|-------|-------|-------|------|-------------|
| 1990    | 12' | 47.00 | 42.00 | 29.00 | 1.20 | 1.900-2.100 |
| 1991    | 12' | 47.00 | 42.00 | 29.00 | 1.40 | 2.200-2.400 |

OUTER FRAME 40 mm SERIES

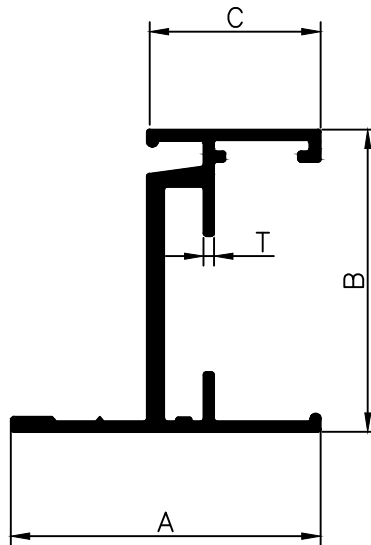

| SEC.No. | C/L | A     | B     | C     | T    | WT. RANGE   |
|---------|-----|-------|-------|-------|------|-------------|
| 1995    | 12' | 41.00 | 40.00 | 22.60 | 1.20 | 1.800-2.100 |
| 1996    | 12' | 41.00 | 40.00 | 22.60 | 1.40 | 2.100-2.300 |

G - CLIP 40 mm SERIES

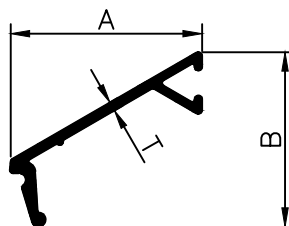

| SEC.No. | C/L | A     | B     | T    | WT. RANGE   |
|---------|-----|-------|-------|------|-------------|
| 2001    | 12' | 25.30 | 23.00 | 1.20 | 0.550-0.650 |

LOUVER SECTION

SEC.No.-2006

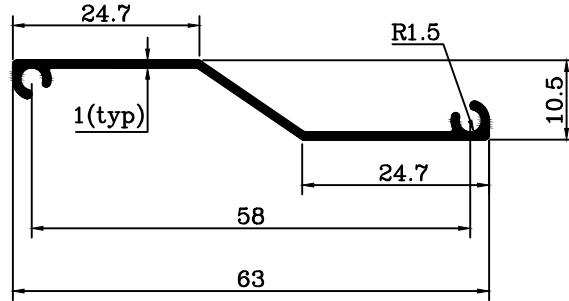

WEIGHT: 0.810 kg/12'

SEC.No.-2007

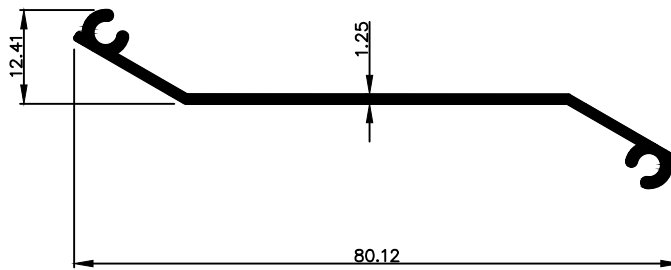

WEIGHT: 1.700 kg/16'

SEC.No.-2011

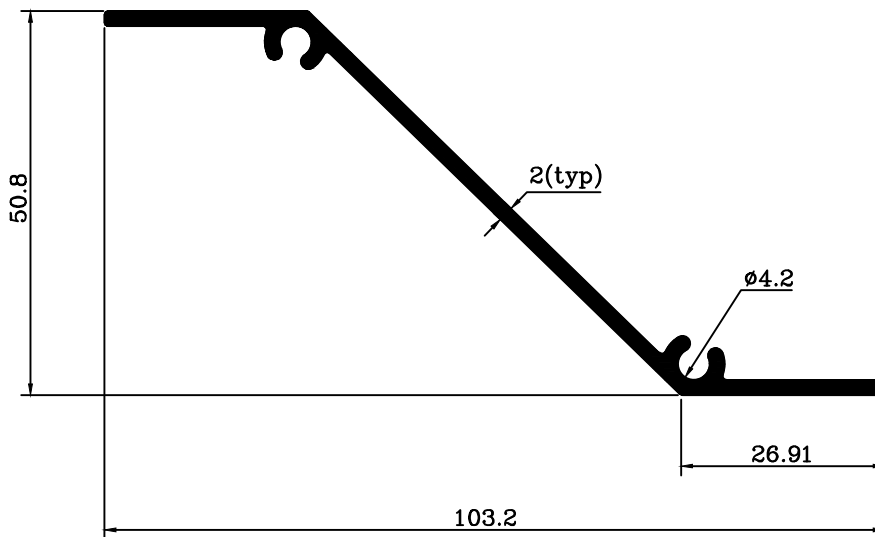

WEIGHT: 2.770 kg/12'

ROD

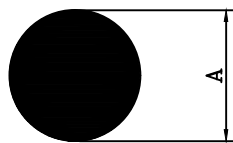

| SEC.No. | C/L | A     | WT. RANGE   |
|---------|-----|-------|-------------|
| 2021    | 12' | 9.000 | 0.600-0.630 |
| 2022    | 12' | 9.100 | 0.630-0.660 |
| 2023    | 12' | 9.400 | 0.660-0.695 |
| 2024    | 12' | 9.700 | 0.710-0.740 |
| 2025    | 12' | 9.800 | 0.730-0.770 |
| 2026    | 12' | 10.00 | 0.770-0.800 |
| 2027    | 12' | 10.70 | 0.870-0.905 |
| 2028    | 12' | 11.40 | 0.975-1.050 |
| 2029    | 12' | 11.60 | 1.010-1.050 |
| 2030    | 12' | 11.90 | 1.080-1.100 |
| 2031    | 12' | 14.40 | 1.565-1.650 |
| 2032    | 12' | 14.80 | 1.700-1.750 |
| 2033    | 12' | 15.50 | 1.840-1.885 |
| 2035    | 12' | 16.00 | 2.000-2.100 |
| 2034    | 12' | 17.30 | 2.250-2.350 |
| 2036    | 12' | 20.00 | 3.100-3.200 |

HEXAGONAL ROD

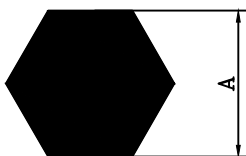

| SEC.No. | C/L | A     | WT. RANGE   |
|---------|-----|-------|-------------|
| 2051    | 12' | 17.40 | 2.600-2.650 |
| 2052    | 12' | 17.80 | 2.700-2.760 |
| 2053    | 12' | 18.70 | 3.000-3.100 |

FLAT BAR

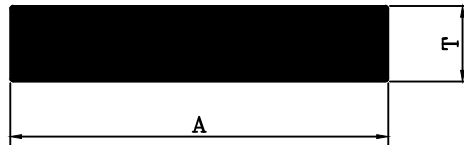

| SEC.No. | C/L | A     | T     | WT. RANGE     |
|---------|-----|-------|-------|---------------|
| 2095    | 12' | 19.0  | 2.50  | 0.470-0.530   |
| 2070    | 12' | 25.00 | 2.000 | 0.490-0.540   |
| 2071    | 12' | 25.00 | 3.000 | 0.750-0.850   |
| 2072    | 12' | 25.00 | 5.000 | 1.200-1.400   |
| 2073    | 12' | 25.00 | 6.000 | 1.500-1.700   |
| 2074    | 12' | 25.00 | 10.00 | 2.500-2.700   |
| 2075    | 12' | 25.40 | 5.500 | 1.250-1.450   |
| 2076    | 12' | 25.40 | 10.00 | 2.400-2.600   |
| 2077    | 12' | 28.00 | 6.000 | 1.650-1.850   |
| 2088    | 12' | 30.00 | 6.00  | 1.750-2.000   |
| 2089    | 12' | 30.00 | 10.00 | 2.950-3.200   |
| 2078    | 12' | 35.00 | 3.000 | 1.036-1.136   |
| 2092    | 12' | 38.00 | 6.000 | 2.200-2.600   |
| 2091    | 12' | 38.00 | 10.00 | 3.700-4.100   |
| 2079    | 12' | 40.00 | 6.000 | 2.400-2.600   |
| 2080    | 12' | 40.00 | 10.00 | 4.000-4.200   |
| 2093    | 12' | 48.0  | 3.80  | 1.800-2.000   |
| 2094    | 12' | 50.0  | 4.60  | 2.300-2.700   |
| 2081    | 12' | 50.00 | 6.000 | 3.000-3.200   |
| 2082    | 12' | 50.00 | 10.00 | 4.950-5.150   |
| 2096    | 12' | 60.00 | 12.00 | 7.000-8.000   |
| 2097    | 12' | 50.00 | 3.00  | 1.500-2.000   |
| 2083    | 12' | 60.00 | 10.00 | 5.800-6.000   |
| 2084    | 12' | 75.00 | 5.000 | 3.700-3.900   |
| 2085    | 12' | 75.00 | 6.000 | 4.450-4.650   |
| 2086    | 12' | 100.0 | 6.000 | 5.900-6.100   |
| 2087    | 12' | 100.0 | 10.00 | 9.750-9.950   |
| 2090    | 12' | 100.0 | 12.00 | 11.800-12.200 |

PLAIN ROUND TUBE

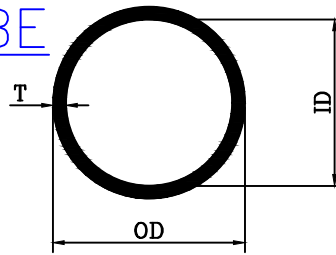

| SEC.No. | C/L | OD    | ID    | T    | WT. RANGE   |
|---------|-----|-------|-------|------|-------------|
| 2101    | 12' | 16.00 | 13.00 | 1.50 | 0.600-0.620 |
| 2102    | 12' | 16.00 | 12.80 | 1.60 | 0.700-0.720 |
| 2100    | 12' | 18.00 | 16.30 | 0.85 | 0.450-0.500 |
| 2116    | 12' | 18.00 | 16.10 | 0.95 | 0.500-0.550 |
| 2117    | 12' | 18.00 | 15.80 | 1.10 | 0.620-0.720 |
| 2118    | 12' | 18.00 | 15.40 | 1.30 | 0.770-0.820 |
| 2104    | 12' | 19.10 | 16.00 | 1.55 | 0.700-0.750 |
| 2119    | 12' | 19.10 | 15.80 | 1.65 | 0.900-1.000 |
| 2103    | 12' | 19.10 | 12.80 | 3.15 | 1.800-1.900 |
| 2105    | 12' | 20.00 | 18.00 | 1.00 | 0.550-0.570 |
| 2106    | 12' | 25.40 | 19.10 | 3.15 | 2.000-2.100 |
| 2107    | 12' | 25.40 | 22.00 | 1.70 | 1.000-1.050 |
| 2108    | 12' | 31.50 | 25.40 | 3.05 | 3.300-3.400 |
| 2109    | 12' | 31.50 | 28.00 | 1.75 | 1.600-1.700 |
| 2110    | 12' | 32.00 | 19.00 | 6.50 | 5.100-5.200 |
| 2111    | 12' | 38.00 | 22.00 | 8.00 | 7.350-7.450 |
| 2112    | 12' | 38.00 | 35.00 | 1.50 | 1.700-1.800 |
| 2113    | 12' | 50.00 | 40.00 | 5.00 | 6.950-7.200 |
| 2114    | 12' | 60.00 | 45.00 | 5.00 | 8.400-8.500 |
| 2115    | 12' | 63.00 | 57.00 | 3.00 | 6.000-6.200 |
| 2120    | 12' | 76.00 | 70.60 | 2.70 | 6.150-6.250 |

FLUTED ROUND TUBE

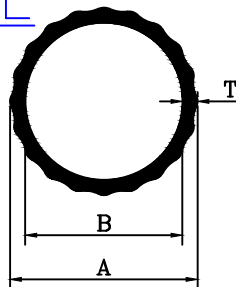

| SEC.No. | C/L | A     | B     | T    | WT. RANGE   |
|---------|-----|-------|-------|------|-------------|
| 2131    | 12' | 24.80 | 20.80 | 2.00 | 1.250-1.450 |
| 2128    | 12' | 25.40 | 23.60 | 0.90 | 0.450-0.520 |
| 2129    | 12' | 25.40 | 23.40 | 1.00 | 0.520-0.600 |
| 2130    | 12' | 25.00 | 22.70 | 1.35 | 0.650-0.725 |

TOWER BOLT

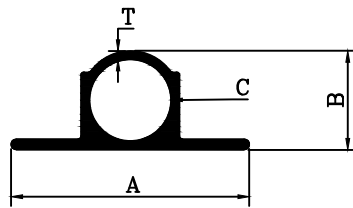

| SEC.No. | C/L | A     | B     | C     | T    | WT. RANGE    |
|---------|-----|-------|-------|-------|------|--------------|
| 2141    | 12' | 31.50 | 13.10 | 10.80 | 1.10 | 0.850-0.1050 |

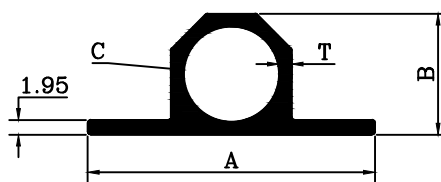

| SEC.No. | C/L | A     | B     | C     | T    | WT. RANGE   |
|---------|-----|-------|-------|-------|------|-------------|
| 2146    | 12' | 38.00 | 16.00 | 12.60 | 1.70 | 1.500-1.600 |

STEP LADDER

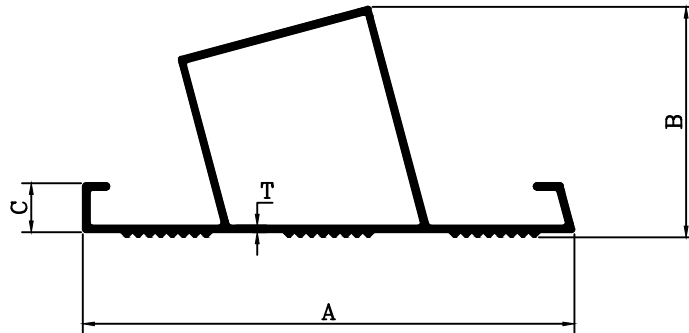

| SEC.No. | C/L | A     | B     | C    | T    | WT. RANGE   |
|---------|-----|-------|-------|------|------|-------------|
| 2151    | 12' | 65.00 | 30.50 | 6.50 | 0.90 | 1.500-1.700 |
| 2152    | 12' | 65.00 | 30.50 | 6.50 | 1.10 | 1.700-2.000 |

C LADDER

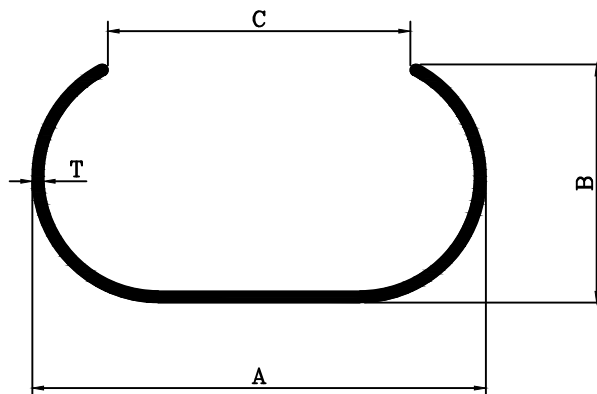

| SEC.No. | C/L | A     | B     | C     | T    | WT. RANGE   |
|---------|-----|-------|-------|-------|------|-------------|
| 2156    | 12' | 60.00 | 31.50 | 40.00 | 1.50 | 1.600-1.800 |
| 2157    | 12' | 66.00 | 31.50 | 40.00 | 2.40 | 2.800-3.100 |
| 2158    | 12' | 66.00 | 31.50 | 40.00 | 3.00 | 3.400-3.700 |

C HANDLE

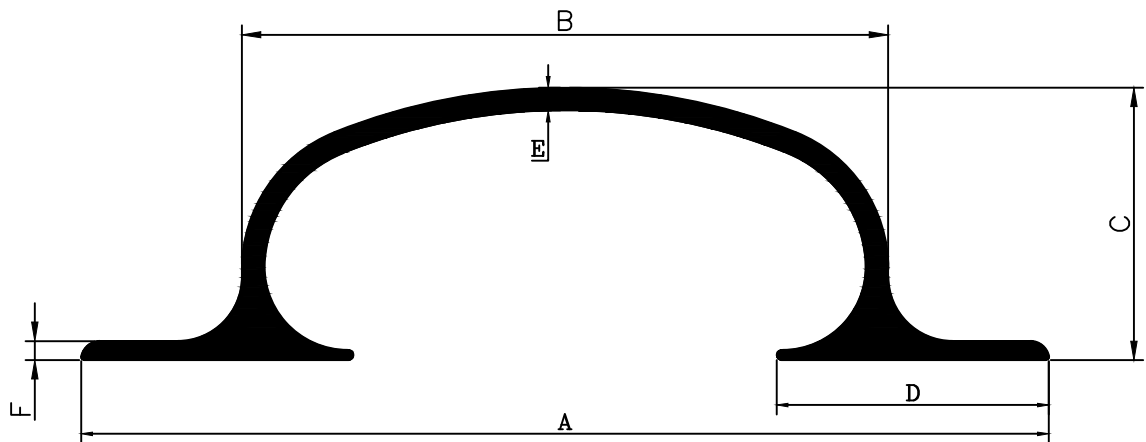

| SEC.No. | C/L | A     | B     | C     | D     | E    | F    | WT. RANGE   |
|---------|-----|-------|-------|-------|-------|------|------|-------------|
| 2166    | 12' | 100.7 | 64.50 | 27.80 | 32.00 | 2.35 | 1.80 | 3.500-3.800 |
| 2167    | 12' | 128.0 | 85.50 | 36.00 | 36.00 | 3.00 | 2.50 | 5.900-6.200 |

D HANDLE

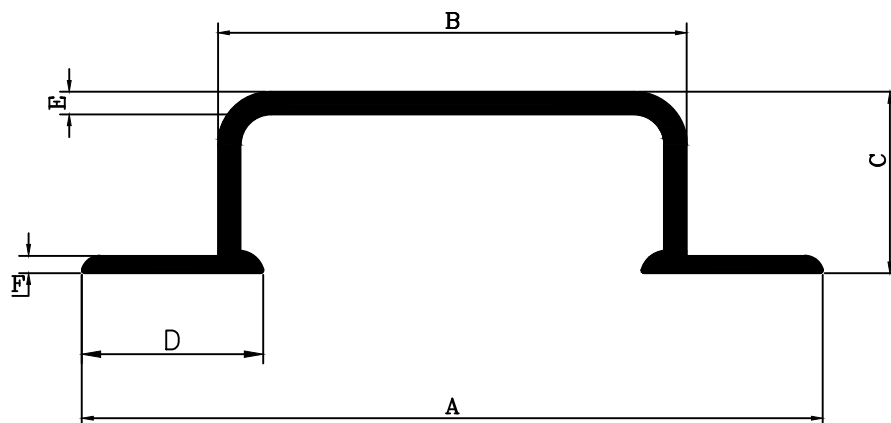

| SEC.No. | C/L | A     | B     | C     | D     | E    | F    | WT. RANGE   |
|---------|-----|-------|-------|-------|-------|------|------|-------------|
| 2176    | 12' | 98.00 | 62.00 | 24.00 | 24.00 | 3.00 | 2.30 | 3.850-4.150 |
| 2177    | 12' | 121.0 | 83.00 | 30.00 | 26.50 | 2.90 | 3.60 | 5.500-5.800 |

EQUAL ANGLE

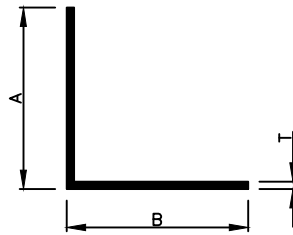

| SEC.No. | C/L | A     | B     | T    | WEIGHT      |
|---------|-----|-------|-------|------|-------------|
| 2184    | 12  | 19.00 | 19.00 | 1.06 | 0.380-0.420 |
| 2192    | 12  | 19.00 | 19.00 | 1.40 | 0.500-0.650 |
| 2185    | 12  | 24.00 | 24.00 | 0.86 | 0.350-0.380 |
| 2186    | 12  | 25.00 | 25.00 | 1.00 | 0.500-0.600 |
| 2187    | 12  | 25.00 | 25.00 | 1.50 | 0.700-0.800 |
| 2191    | 12  | 25.00 | 25.00 | 1.80 | 0.850-1.100 |
| 2188    | 12  | 25.00 | 25.00 | 2.35 | 1.100-1.300 |
| 2189    | 12  | 25.00 | 25.00 | 3.00 | 1.400-1.600 |
| 2198    | 12  | 38.00 | 38.00 | 3.00 | 2.200-2.500 |
| 2190    | 12  | 50.00 | 50.00 | 3.00 | 2.900-3.200 |
|         |     |       |       |      |             |
|         |     |       |       |      |             |

UNEQUAL ANGLE

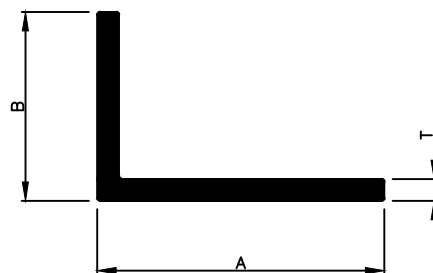

| SEC.No. | C/L | A     | B     | T    | WEIGHT      |
|---------|-----|-------|-------|------|-------------|
| 2195    | 12  | 38.00 | 25.00 | 2.18 | 1.300-1.600 |
| 2196    | 12  | 38.00 | 25.00 | 2.30 | 1.600-1.900 |
| 2197    | 12  | 38.00 | 25.00 | 2.90 | 2.000-2.200 |
| 2199    | 12  | 50.00 | 25.00 | 2.40 | 1.700-2.000 |

BULB TEE

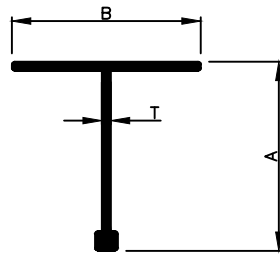

| SEC.No. | C/L | A     | B     | T    | WEIGHT      |
|---------|-----|-------|-------|------|-------------|
| 2204    | 12  | 24.00 | 24.00 | 0.62 | 0.300-0.500 |
| 2206    | 12  | 25.00 | 25.00 | 1.20 | 0.600-0.700 |
| 2208    | 12  | 25.00 | 25.00 | 1.45 | 0.700-0.800 |
| 2207    | 12  | 38.10 | 25.40 | 1.15 | 0.750-0.850 |
| 2209    | 12  | 38.10 | 25.40 | 1.45 | 0.950-1.050 |

PLAIN TEE

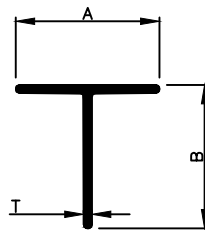

| SEC.No. | C/L | A     | B     | T    | WEIGHT      |
|---------|-----|-------|-------|------|-------------|
| 2215    | 12  | 19.00 | 19.00 | 0.77 | 0.280-0.350 |
| 2216    | 12  | 19.00 | 19.00 | 1.10 | 0.400-0.500 |
| 2217    | 12  | 25.00 | 25.00 | 0.90 | 0.400-0.500 |

SEC.No. – 2221

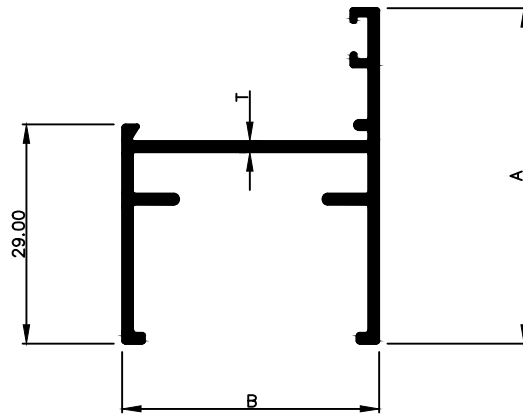

| SEC.No. | C/L | A     | B    | T    | WEIGHT      |
|---------|-----|-------|------|------|-------------|
| 2221    | 16  | 44.45 | 34.0 | 1.03 | 1.700–2.000 |
| 2222    | 16  | 44.45 | 34.0 | 1.25 | 2.000–2.300 |
| 2223    | 16  | 44.45 | 34.0 | 1.45 | 2.300–2.600 |
| 2224    | 16  | 44.45 | 34.0 | 1.70 | 2.700–3.000 |

G CHANNEL

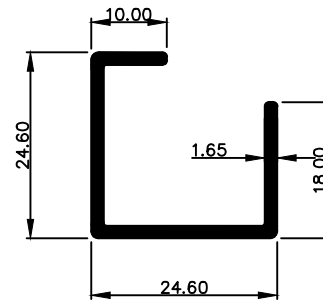
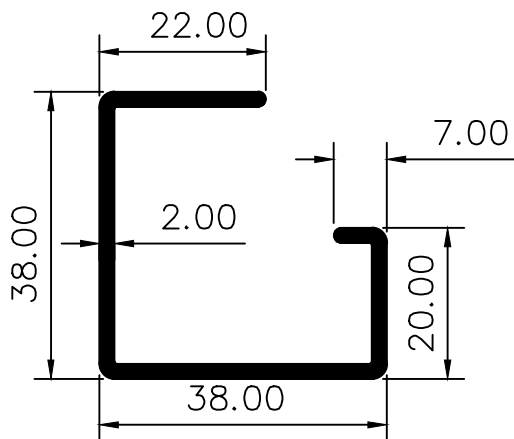

| SEC.No. | C/L | A     | B     | T    | WEIGHT      |
|---------|-----|-------|-------|------|-------------|
| 2227    | 12  | 24.60 | 24.60 | 1.65 | 1.100–1.500 |
| 2226    | 12  | 38.00 | 38.00 | 2.00 | 2.200–2.500 |
| 2228    | 12  | 38.00 | 38.00 | 2.35 | 2.600–2.800 |
| 2229    | 12  | 38.00 | 38.00 | 2.55 | 2.800–3.100 |

DOUBLE GLASS CHANNEL

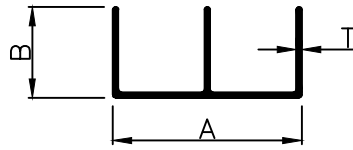

| SEC.No. | C/L | A     | B     | T    | WEIGHT      |
|---------|-----|-------|-------|------|-------------|
| 2237    | 12  | 16.00 | 11.00 | 0.70 | 0.310-0.360 |
| 2238    | 12  | 18.00 | 11.00 | 0.66 | 0.310-0.360 |
| 2239    | 12  | 18.00 | 11.00 | 0.80 | 0.380-0.430 |
| 2240    | 12  | 18.00 | 11.00 | 1.04 | 0.480-0.530 |
| 2244    | 12  | 18.50 | 11.00 | 0.65 | 0.310-0.360 |
| 2245    | 12  | 18.50 | 11.00 | 0.80 | 0.380-0.430 |
| 2246    | 12  | 18.50 | 12.00 | 0.96 | 0.480-0.530 |
| 2243    | 12  | 18.50 | 12.00 | 1.11 | 0.550-0.600 |
| 2241    | 12  | 22.00 | 11.00 | 0.63 | 0.320-0.370 |
| 2255    | 12  | 22.00 | 11.00 |      | 0.240-0.280 |
| 2256    | 12  | 22.00 | 11.00 |      | 0.280-0.320 |
| 2231    | 12  | 22.00 | 12.00 | 0.75 | 0.400-0.450 |
| 2232    | 12  | 22.00 | 12.00 | 1.02 | 0.550-0.600 |
| 2233    | 12  | 22.00 | 12.00 | 1.20 | 0.650-0.700 |
| 2242    | 12  | 25.00 | 11.00 | 0.70 | 0.380-0.430 |
| 2257    | 12  | 25.00 | 12.00 |      | 0.280-0.320 |
| 2234    | 12  | 25.00 | 12.00 | 0.72 | 0.400-0.450 |
| 2235    | 12  | 25.00 | 12.00 | 0.93 | 0.520-0.570 |
| 2236    | 12  | 25.00 | 12.00 | 0.98 | 0.550-0.600 |
| 2247    | 12  | 25.00 | 12.00 | 1.15 | 0.650-0.700 |
| 2258    | 12  | 25.00 | 12.00 |      | 0.850-0.950 |
| 2248    | 12  | 32.00 | 12.00 | 1.02 | 0.650-0.750 |
| 2249    | 12  | 35.00 | 14.00 | 0.68 | 0.500-0.550 |
| 2250    | 12  | 35.00 | 14.00 | 0.95 | 0.690-0.740 |

GRILL ' Y ' CHANNEL

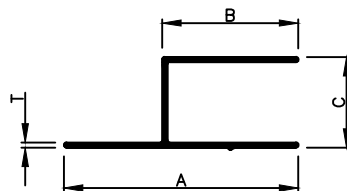

| SEC.No. | C/L | A     | B     | C     | T    | WEIGHT      |
|---------|-----|-------|-------|-------|------|-------------|
| 2440    | 12  | 31.00 | 18.00 | 12.00 | 0.68 | 0.400-0.500 |
| 2441    | 12  | 31.00 | 18.00 | 12.00 | 0.87 | 0.500-0.600 |
|         |     |       |       |       |      |             |

SEC.No. – 2261

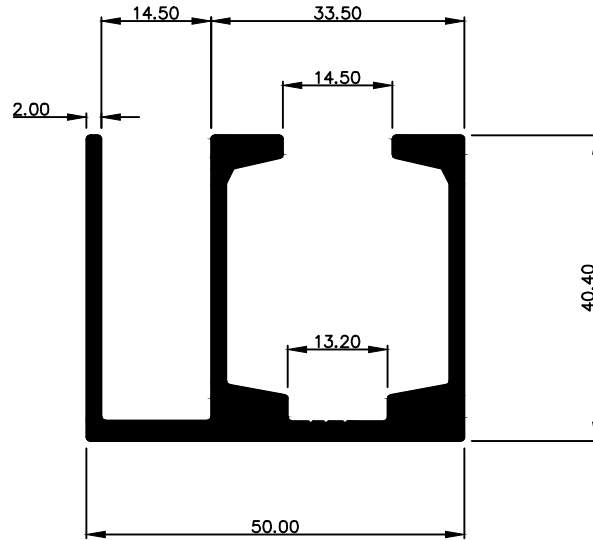

WEIGHT: – 4.700 – 5.000 kg/12'

3 X 1" HANDLE

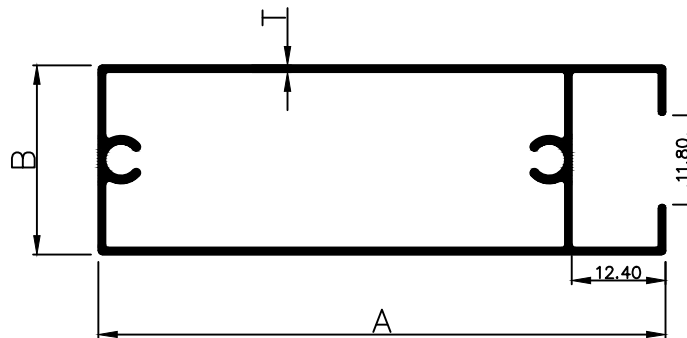

| SEC.No. | C/L | A     | B     | T    | WEIGHT        |
|---------|-----|-------|-------|------|---------------|
| 2271    | 16  | 75.00 | 25.00 | 0.90 | 2.700 – 3.000 |
|         |     |       |       |      |               |
|         |     |       |       |      |               |

3 X 1" TOP BOTTOM

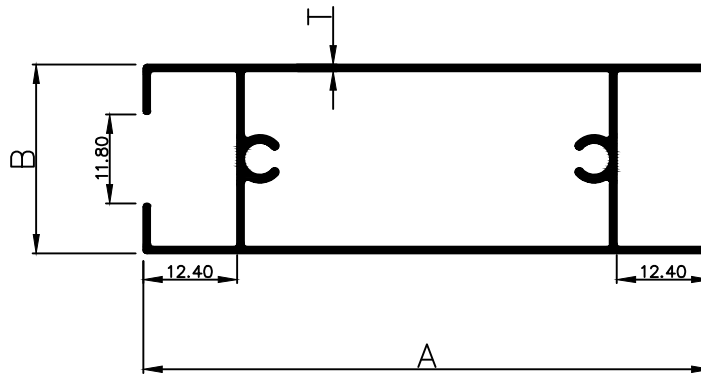

| SEC.No. | C/L | A     | B     | T    | WEIGHT      |
|---------|-----|-------|-------|------|-------------|
| 2281    | 16  | 75.00 | 25.00 | 0.90 | 2.700-3.000 |
|         |     |       |       |      |             |
|         |     |       |       |      |             |

3 X 1" MATTING

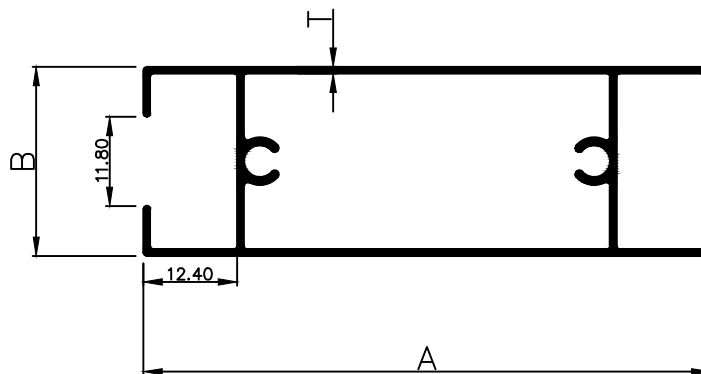

| SEC.No. | C/L | A     | B     | T    | WEIGHT      |
|---------|-----|-------|-------|------|-------------|
| 2291    | 15  | 75.00 | 25.00 | 0.85 | 2.500-2.800 |
| 2290    | 16  | 75.00 | 25.00 | 0.90 | 2.800-3.100 |
| 2292    | 16  | 75.00 | 25.00 | 1.00 | 3.200-3.500 |

3 X 3/4" MATTING

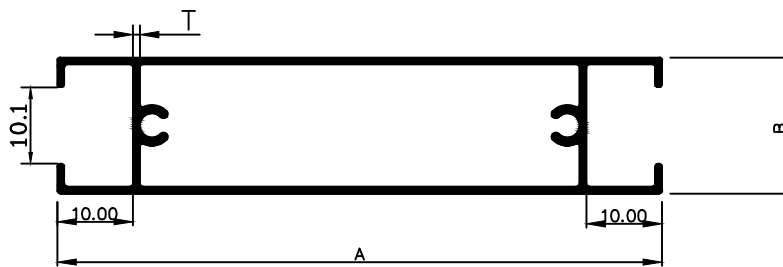

| SEC.No. | C/L | A     | B     | T    | WEIGHT      |
|---------|-----|-------|-------|------|-------------|
| 2296    | 12  | 80.00 | 18.00 | 0.90 | 2.000-2.300 |
| 2297    | 12  | 80.00 | 18.00 | 1.15 | 2.400-2.700 |
|         |     |       |       |      |             |

3 X 3/4" HANDLE

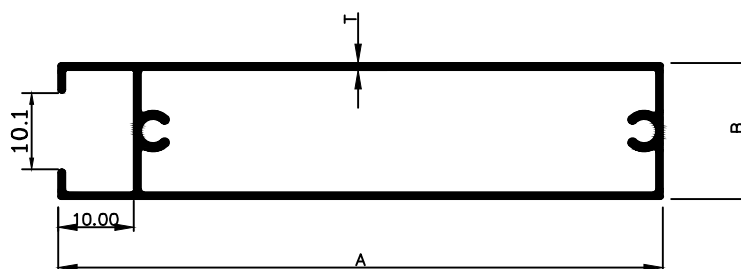

| SEC.No. | C/L | A     | B     | T    | WEIGHT      |
|---------|-----|-------|-------|------|-------------|
| 2275    | 12  | 80.00 | 18.00 | 0.92 | 2.000-2.200 |
|         |     |       |       |      |             |

SEC.No.-2330

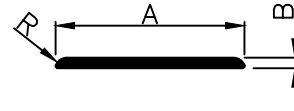
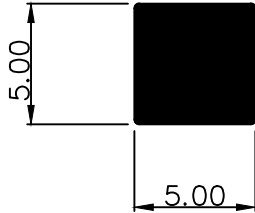

| SEC.No. | C/L | A     | B    | R    | WT. RANGE   |
|---------|-----|-------|------|------|-------------|
| 2354    | 12' | 25.00 | 1.20 | 1.60 | 0.280-0.330 |
| 2355    | 12' | 25.00 | 1.40 | 1.60 | 0.350-0.410 |
| 2356    | 12' | 25.00 | 1.60 | 2.00 | 0.410-0.460 |
| 2357    | 12' | 25.00 | 1.75 | 2.00 | 0.470-0.520 |
|         |     |       |      |      |             |
|         |     |       |      |      |             |
|         |     |       |      |      |             |

WEIGHT:- 0.245-0.450 kg/12'

SEC.No.-2370

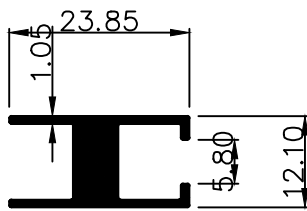

WEIGHT:- 1.134 kg/12'

SEC.No.-2380

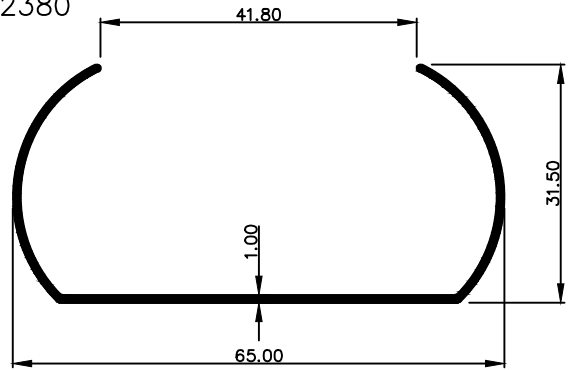

WEIGHT:- 1.200-1.400 kg/12'

SEC.No.-2381

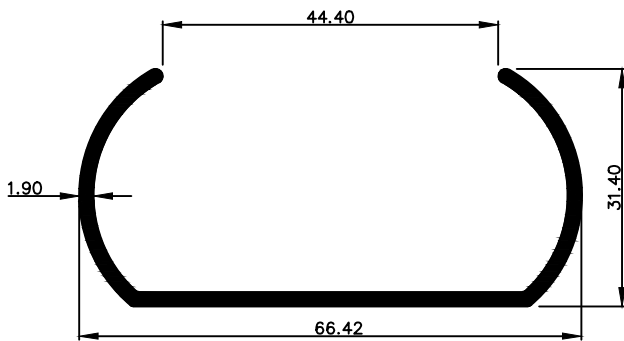

WEIGHT:- 2.300-2.500 kg/12'

SEC.No.-2390

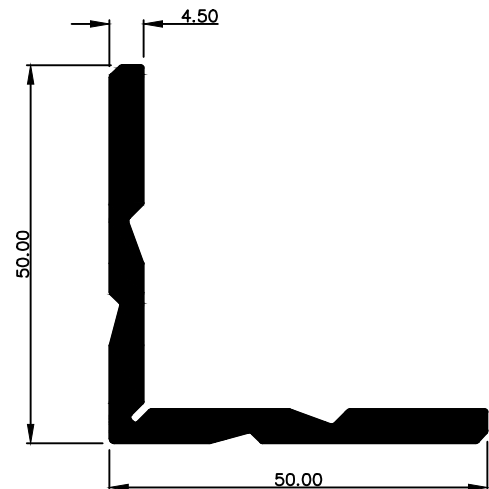

WEIGHT:- 3.900-4.200 kg/12'

# VIKASH ALUMINIUM PVT. LTD.

SEC.No.-2400

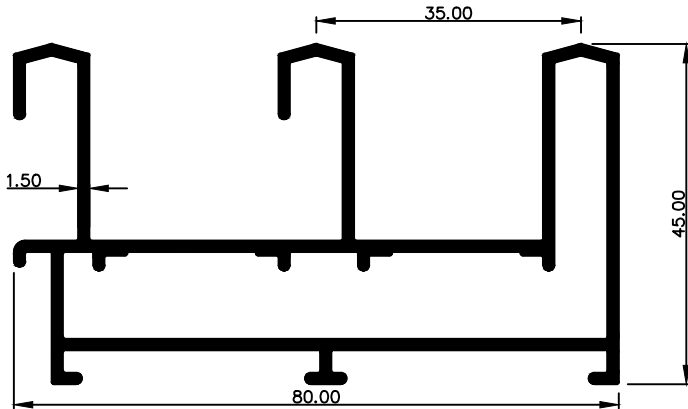

| SEC.No. | C/L | T    | WEIGHT      |
|---------|-----|------|-------------|
| 2400    | 12  | 1.50 | 5.100-5.400 |
| 2401    | 12  | 1.20 | 4.100-4.500 |

SEC.No.-2405

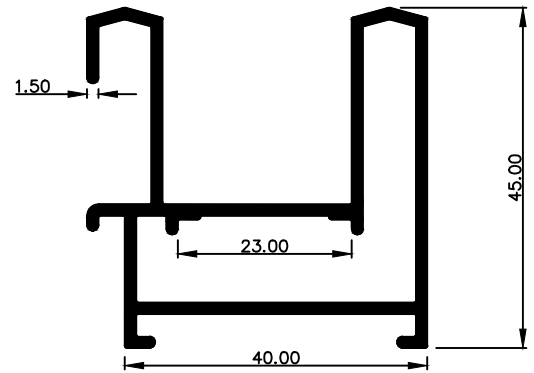

| SEC.No. | C/L | T    | WEIGHT      |
|---------|-----|------|-------------|
| 2405    | 12  | 1.50 | 3.200-3.500 |
| 2406    | 12  | 1.20 | 2.600-2.800 |

SEC.No.-2411

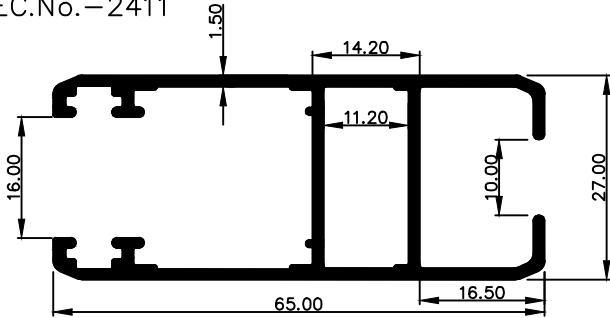

| SEC.No. | C/L | T    | WEIGHT      |
|---------|-----|------|-------------|
| 2411    | 12  | 1.50 | 3.200-3.500 |
| 2412    | 12  | 1.20 | 2.600-2.800 |

SEC.No.-2416

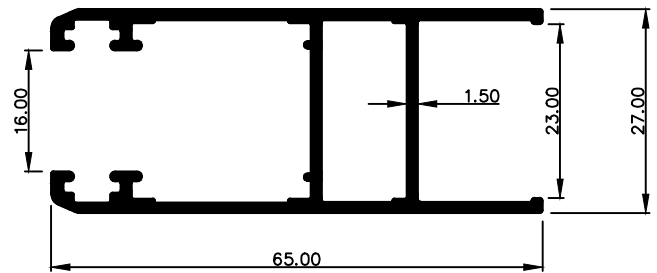

| SEC.No. | C/L | T    | WEIGHT      |
|---------|-----|------|-------------|
| 2416    | 12  | 1.50 | 3.000-3.200 |
| 2417    | 12  | 1.20 | 2.400-2.700 |

SEC.No.-2421

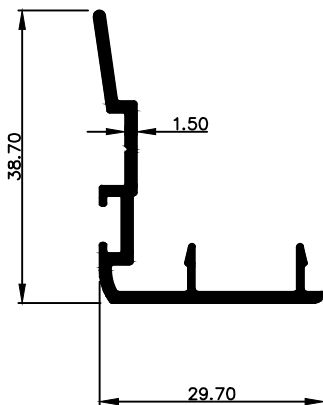

WEIGHT:- 1.200-1.400 kg/12'

SEC.No.-2426

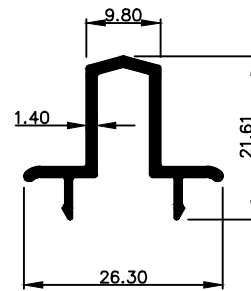

WEIGHT:- 0.850-0.950 kg/12'

SEC.No.-2431

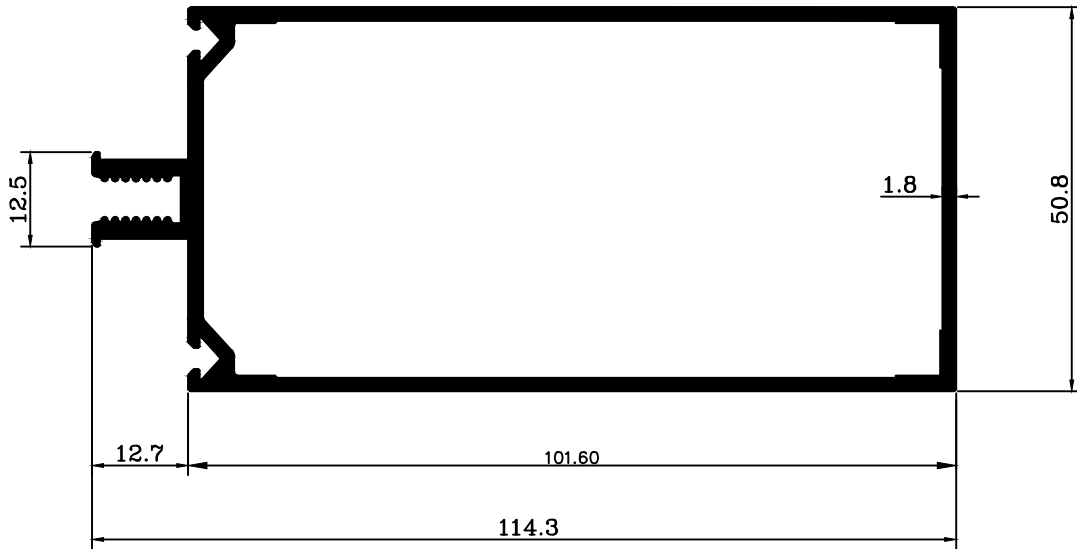

WEIGHT:- 6.350-6.700 kg/12'

SEC.No.-2436

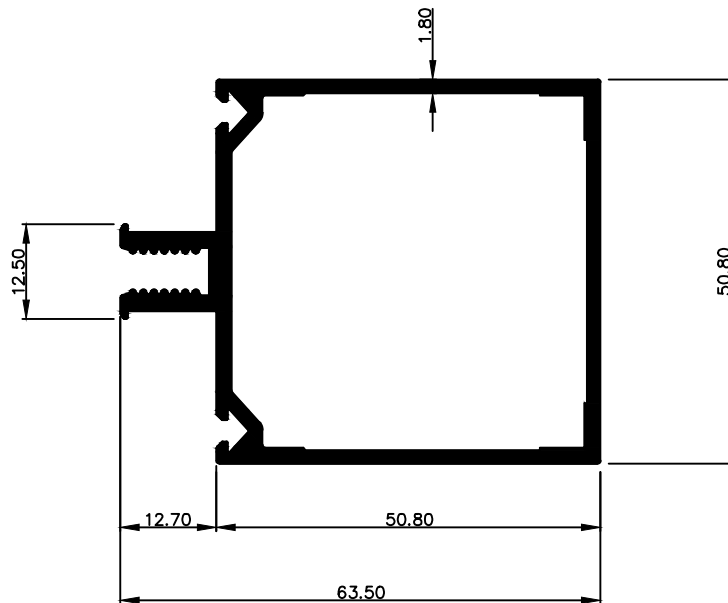

WEIGHT:- 4.500-4.800 kg/12'

SEC. NO:- 2437

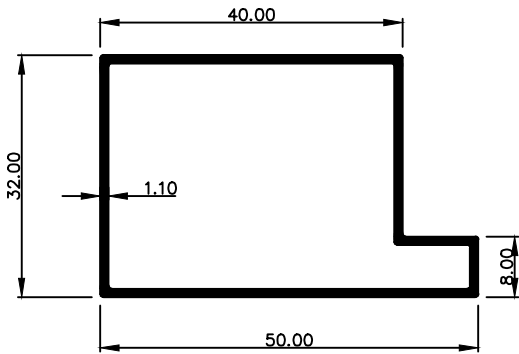

WEIGHT:- 1.700-1.900 kg/12'

SEC. NO:- 2438

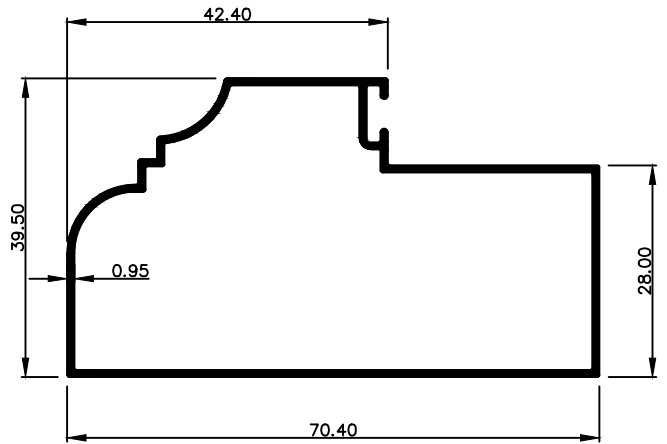

WEIGHT:- 2.000-2.300 kg/12'

SEC. NO:- 2439

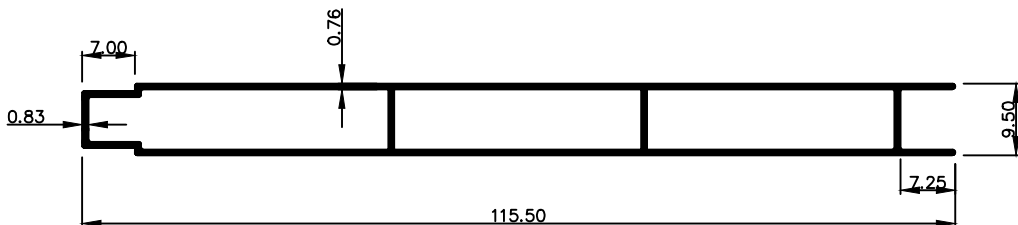

WEIGHT:- 2.000-2.300 kg/12'

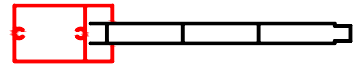

SEC. NO:- 2445

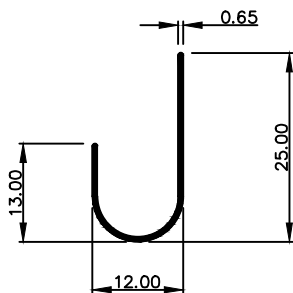

WEIGHT:- 0.280-0.310 kg/12'

SEC. NO:- 2451

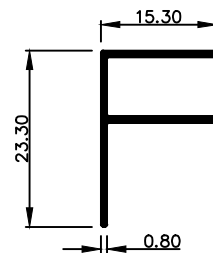

WEIGHT:- 0.400-0.550 kg/12'

SEC. NO:- 2456

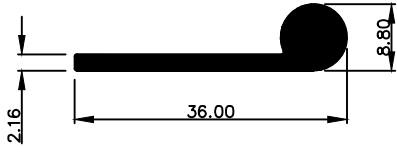

WEIGHT:- 1.200-1.400 kg/12'

SEC. NO:- 2457

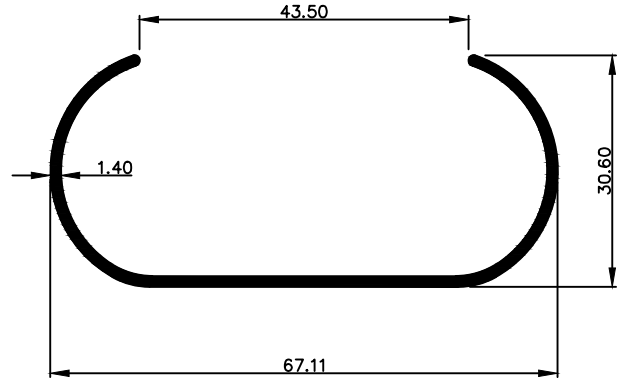

WEIGHT:- 1.700-2.000 kg/12'

| SEC.No. | C/L | T    | WEIGHT      |
|---------|-----|------|-------------|
| 2472    | 12  | 0.90 | 1.000-1.200 |
| 2457    | 12  | 1.40 | 1.700-2.000 |

SEC. NO:- 2458

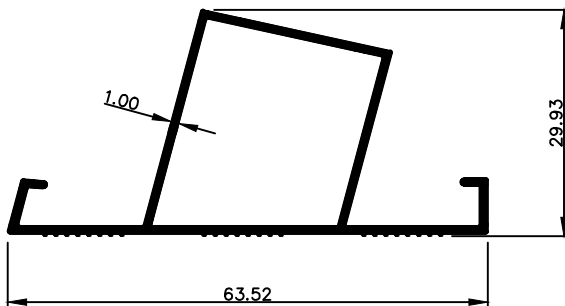

WEIGHT:- 1.600-1.800 kg/12'

SEC. NO:- 2459

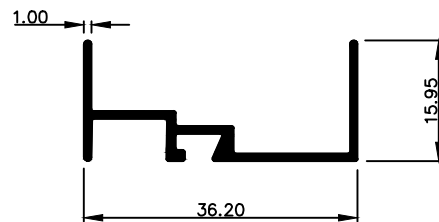

WEIGHT:- 0.800-1.000 kg/12'

SEC. NO:- 2460

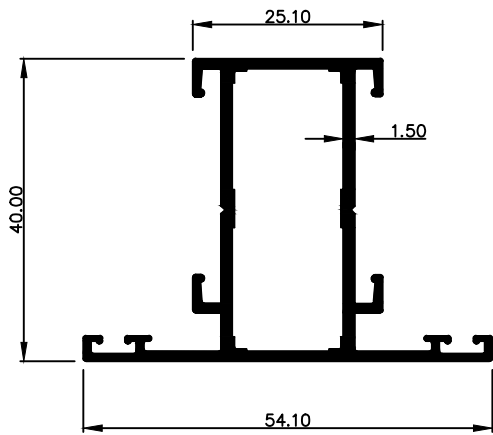

WEIGHT:- 2.500-2.800 kg/12'

SEC. NO:- 2465

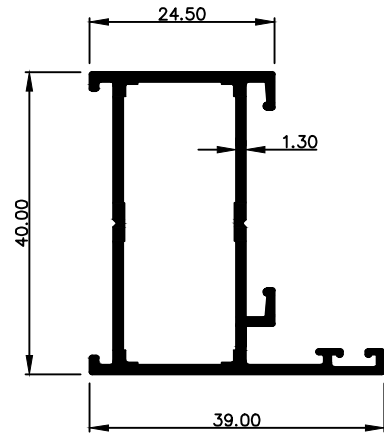

WEIGHT:- 2.000-2.300 kg/12'

SEC. NO:- 2468

VP-125

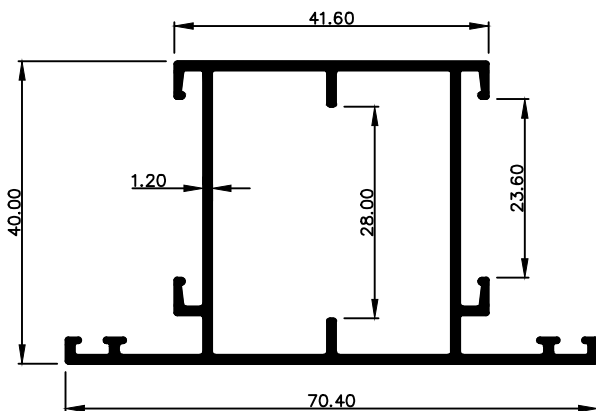

WEIGHT:- 2.700-2.950 kg/12'

SEC. NO:- 2471

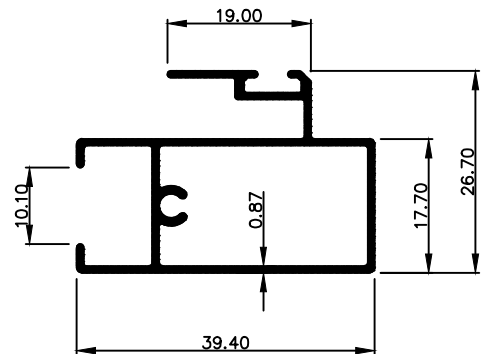

WEIGHT:- 1.390-1.540 kg/12'

SEC. NO:- 2470

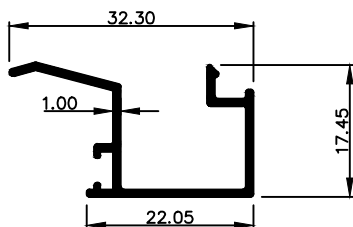

| SEC.No. | C/L | T    | WEIGHT      |
|---------|-----|------|-------------|
| 2470    | 12  | 1.00 | 0.750-0.950 |
| 2470-H  | 12  | 1.45 | 1.100-1.300 |
|         |     |      |             |

SEC. NO:- 2469

VP-264

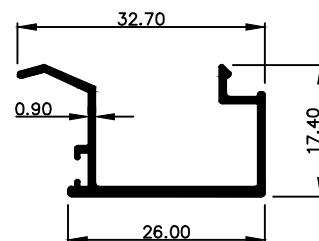

WEIGHT:- 0.750-0.850 kg/12'

SEC. NO:- 2476

VP-121

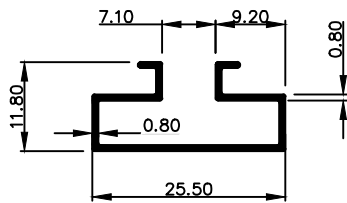

WEIGHT:- 0.550-0.750 kg/12'

SEC. NO:- 2481

VP-153(M)

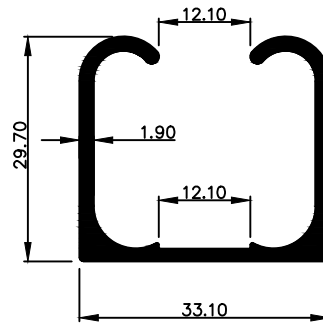

WEIGHT:- 2.000-2.200 kg/12'

SEC. NO:- 2486

VP-173

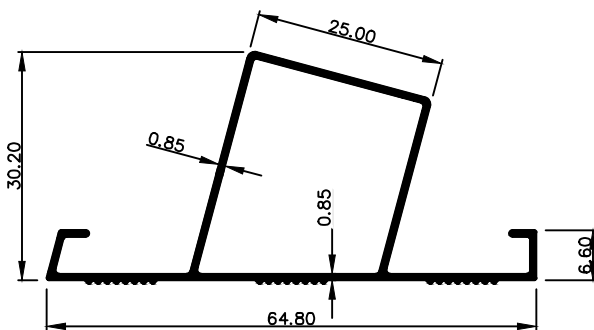

WEIGHT:- 1.400-1.700 kg/12'

SEC. NO:- 2491

VP-174

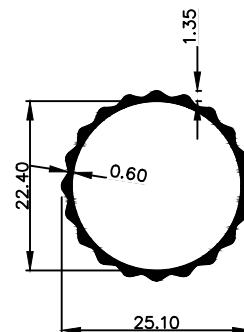

WEIGHT:- 0.700-0.900 kg/12'

SEC. NO:- 2496

VP-123

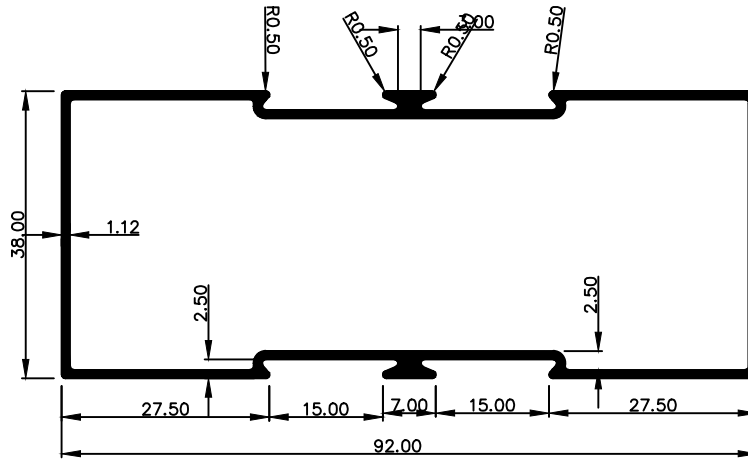

WEIGHT:- 3.200-3.500 kg/12'

SEC. NO:- 2501

VP-124

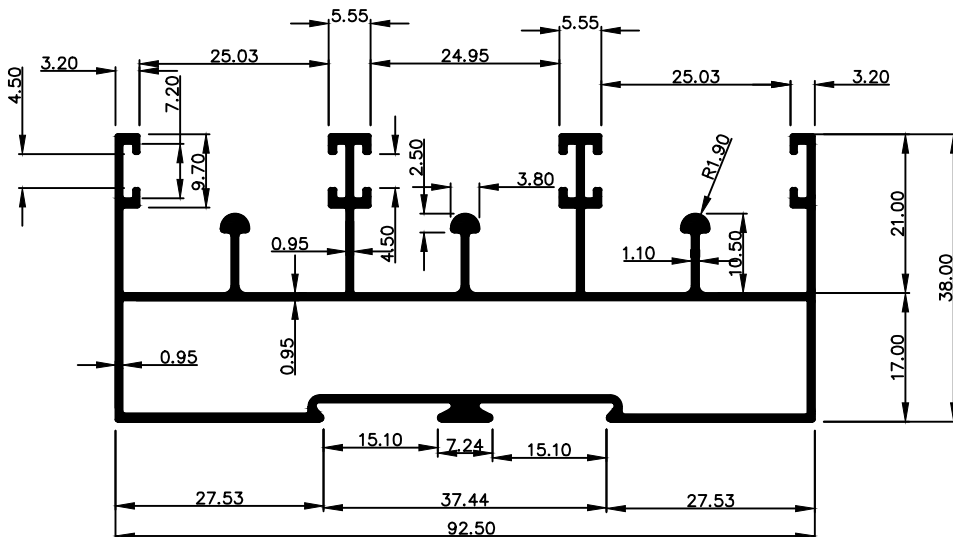

WEIGHT:- 4.000-4.300 kg/12'

SEC. NO:- 2506

VP-126

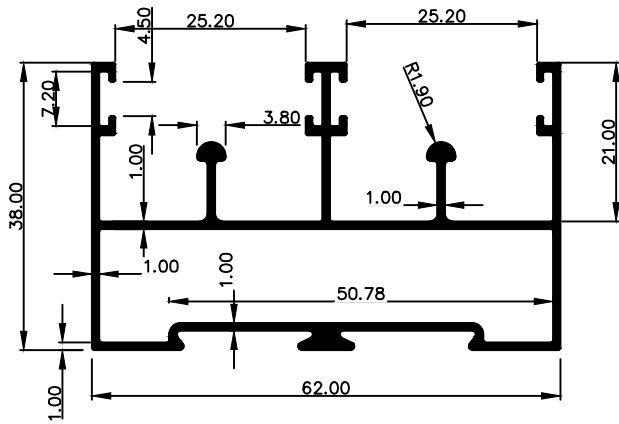

WEIGHT:- 3.000-3.300 kg/12'

SEC. NO:- 2511

VP-136

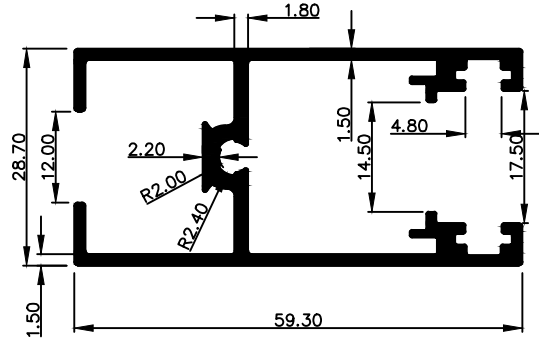

WEIGHT:- 3.200-3.500 kg/12'

SEC. NO:- 2516

VP-137

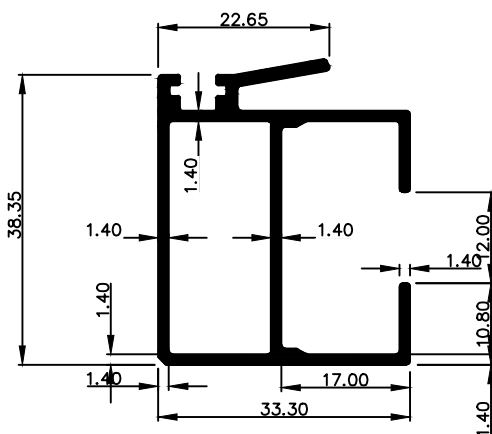

WEIGHT:- 2.400-2.700 kg/12'

SEC. NO:- 2521

VP-138

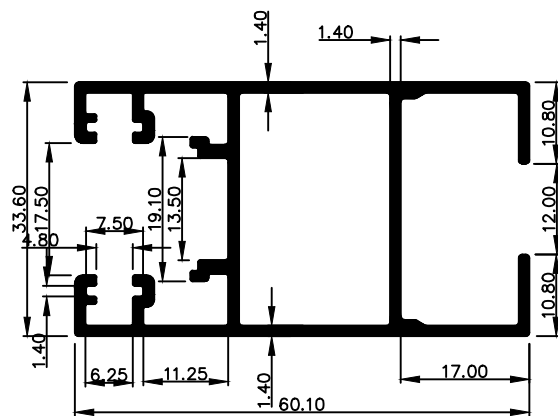

WEIGHT:- 3.500-3.800 kg/12'



SEC. NO:- 2537 VP-254

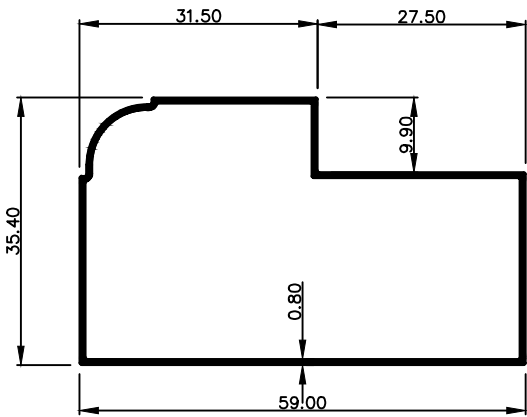

WEIGHT:- 1.300-1.500 kg/12'

SEC. NO:- 2540

VP-244

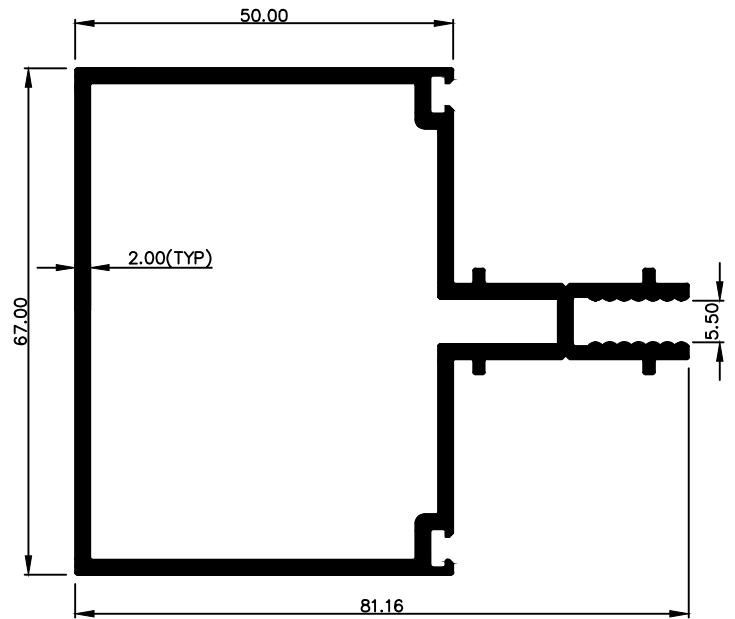

WEIGHT:- 5.900-6.300 kg/12'

SEC. NO:- 2538

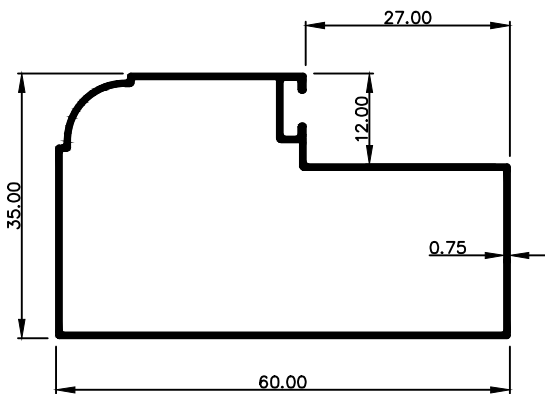

WEIGHT:- 1.400-1.600 kg/12'

SEC. NO:- 2545

VP-240

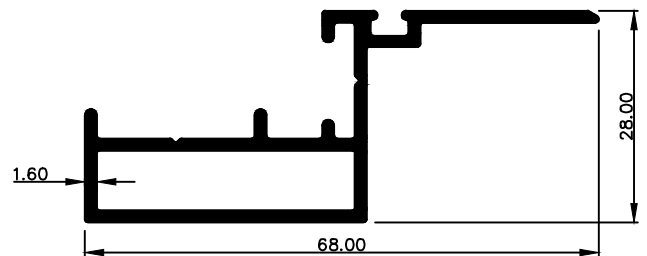

WEIGHT:- 2.500-2.700 kg/12'

SEC. NO:- 2546

VP-239

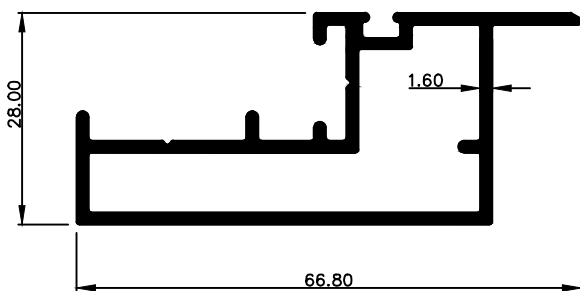

WEIGHT:- 3.050-3.300 kg/12'

SEC. NO:- 2544

VP-241

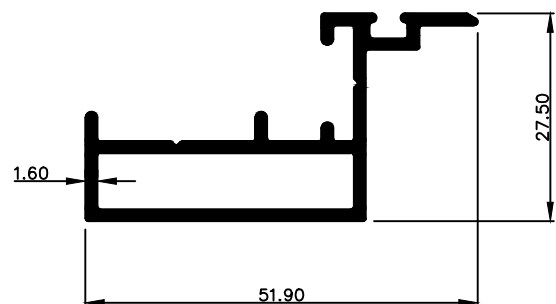

WEIGHT:- 2.200-2.500 kg/12'

SEC. NO:- 2550

VP-295

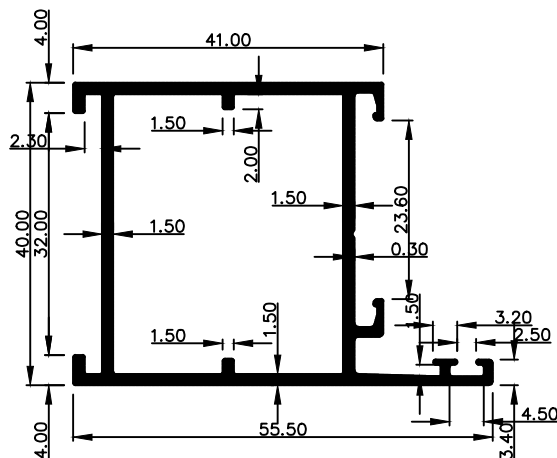

WEIGHT:- 2.800-3.100 kg/12'

SEC. NO:- 1914

VP-319

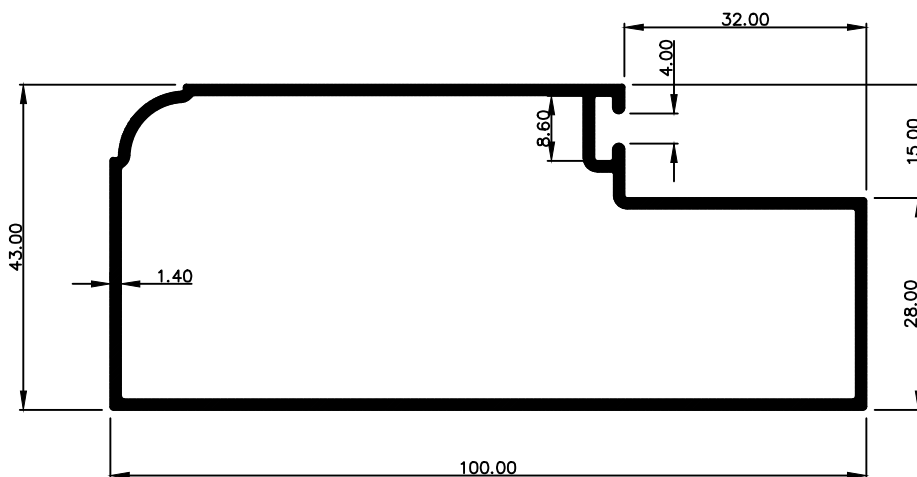

WEIGHT:- 3.9294 Kg/12'

SEC. NO:- 2555

VP-308

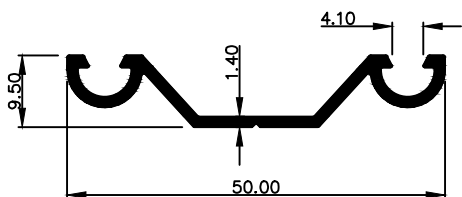

WEIGHT:- 1.0655 Kg/12'

SEC. NO:- 2560

VP-309

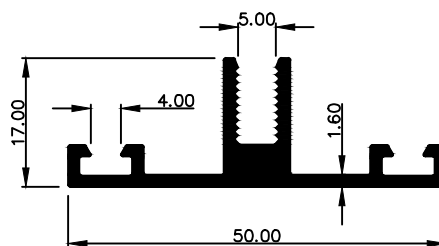

WEIGHT:- 1.8018 Kg/12'